

Manual crimping tool



# Model HT302/DF19S

## INSTRUCTION MANUAL



**CAUTION :**

Be sure to read this Instruction Manual carefully before using it to secure safety in operation. In addition, save this Instruction Manual so that it is available whenever necessary for review.

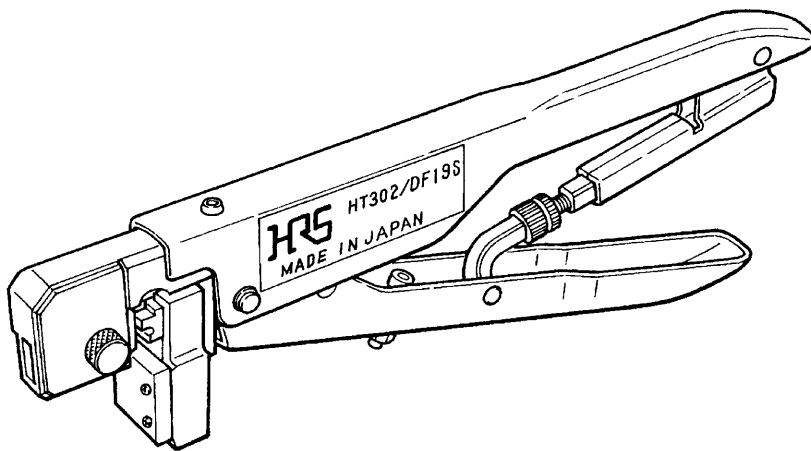

**HIROSE ELECTRIC CO., LTD.**





# FOR SAFE OPERATION

The operators of the tool and the maintenance personnel who are in charge of maintenance and repair work are required to read the following **SAFETY INSTRUCTIONS** so as to avoid injury.

Fully understand the descriptions given in this Instruction Manual and the warning labels attached on the tool, and follow the instructions.

## (I) Description of warning messages

 <b>DANGER</b>	Used in the case where it is assumed that misuse of the tool will expose the operator to immediate danger of major injury or death.
 <b>WARNING</b>	Used in the case where it is assumed that misuse of the tool can expose the operator to danger of major injury or death.
 <b>CAUTION</b>	Used in the case where it is assumed that misuse of the tool can expose the operator to danger of injury and can cause damage to property.

\* Determine the degree of impairment referring to the below-stated classification.

**Major injury** : Indicates the loss of eyesight, wounds, burns (hyperthermal and hypothermal burns), electric shocks, fracture of a bone, poisoning, etc. requiring emergency of extended medical care.

**Injury (Minor injury)** : Indicates wounds, burns, electric shocks, etc. requiring medical treatment.

**Damage to property** : Indicates damage to the machinery and or the surrounding area.

## SAFETY INSTRUCTIONS



**CAUTION**

### Basic safety instructions

1. Be sure to read this Instruction Manual and all the instructions and other materials supplied with the unit as accessories before using the tool. Save this Instruction Manual and make it available for review whenever necessary.

### Safety device

1. Safety device such as safety cover or the like is not provide with the tool. Be sure to use the tool with great care so that your fingers or the like are not allowed to be caught in the handle section when performing crimping operation.

### Application

1. This tool shall only be used for its originally intended purpose while following the instructions specified in this Instruction Manual. Hirose assumes no responsibility for any use of the tool other than the intended use.
2. Modifications to this tool is prohibited. We assume no responsibility for accidents resulting from modifications.

### Maintenance

1. To prevent possible accidents caused by unfamiliarity with the operation of the tool, repair and adjustment of the tool shall be conducted only by maintenance personnel who have a full knowledge of the tool. Any repair and adjustment beyond the range covered by the instructions given in this Instruction Manual is prohibited. We assume no responsibility for accidents caused by improper repair or adjustment or the use of non-genuine part(s).
2. To protect against personal injury, check to be sure that screws and nuts are not loosened after the completion of repair/adjusting works and replacement of parts.
3. Periodically clean the tool as long as it is commissioned.
4. In the event that your tool fails to perform normally after repair or adjusting immediately stop the work and contact us for service so as to protect against personal injury.

## TABLE OF CONTENTS

<b>1. Forward .....</b>	<b>1</b>
<b>2. Precautions in handling the tool and maintenance.....</b>	<b>1</b>
<b>3. Basic outline of crimping operation .....</b>	<b>2</b>
<b>4. Schematic view and nomenclature .....</b>	<b>8</b>
<b>5. Applicable connectors and standard applicable wire .....</b>	<b>9</b>
<b>6. Crimping procedure .....</b>	<b>10</b>
<b>7. Requirements for crimping and crimping quality standard .....</b>	<b>11</b>

# 1. Forward

Congratulations on your purchase of our manual crimping tool.

This is the Instruction Manual for the manual crimping tool.

Please be sure to read and understand this Instruction Manual before putting the tool into service for correct operations.

## 2. Precautions in handling the tool and maintenance

### ■ Precautions in handling

- (1) Fine adjustment of the crimp height cannot be performed with the manual crimping tool. In case the cable to be used is different from the specified one, the cable is not applicable to the tool even when the cable is in the range of applicable cable for the contact.
- (2) Never crimp any material other than applicable contacts and applicable cables given in this Instruction Manual.
- (3) Never apply any physical impact to the tool by tapping or dropping from an elevated place.
- (4) The handle cannot be opened before releasing the ratchet. Forcibly opening the handle is strictly prohibited since doing so can cause the tool to break down.
- (5) If applying an extra load to the handle continuously after the ratchet is released, the handle may sometimes remain closed and fail to open. In this event, put a screwdriver or the like in the handle to open it as shown in Fig. 1.
- (6) If the tool is defective, do not disassemble it but contact us for repair while showing the detailed description of the defect.

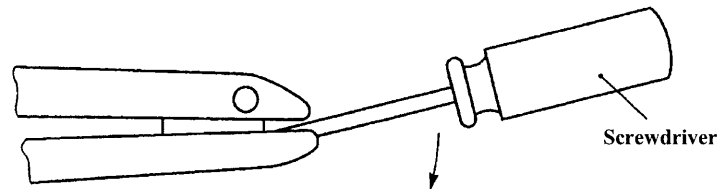

Fig. 1

### ■ Maintenance and inspection

#### Routine maintenance

- (1) Upon completion of works, wipe the tool to remove stains and foreign materials with a piece of soft cloth and close the handle to avoid any foreign material from entering the crimper and the anvil. Then, store the tool in a dry place.
- (2) When opening/closing the handle, check to be sure that the anvil smoothly slides without galling.

### 3. Basic outline of crimping operation

This section describes basic general matters on the crimping operation.

#### 3-1 Configuration and function of crimping contact

##### 3-1-1. Configuration of crimping contact

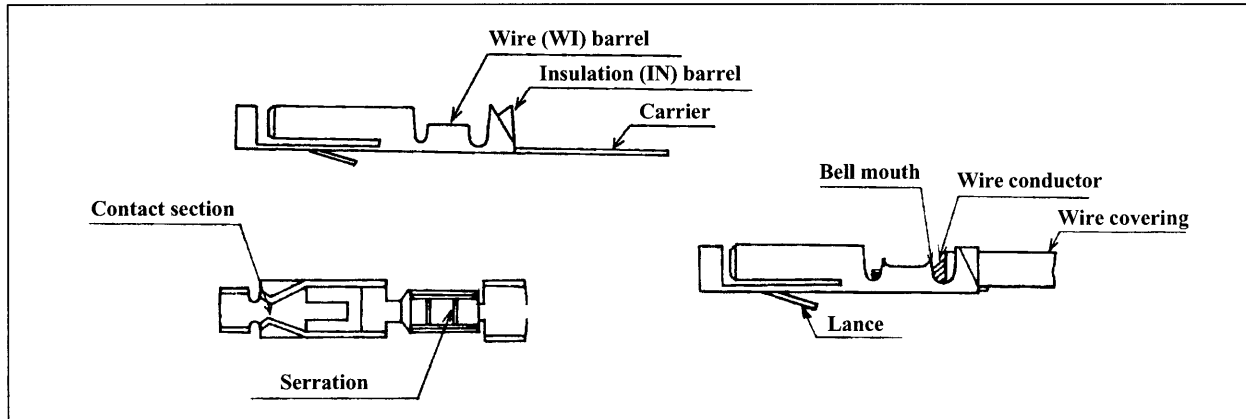

##### 3-1-2. Function of each part of crimping contact

(1) Wire barrel (contact wire crimping section)

This barrel has a shape of letter U and plays a role in caulking and holding the conductor by mechanical force and connecting the conductor to the contact.

The range of applicable wire can be determined by the size of the wire barrel. The required performance cannot be obtained if the wire other than the applicable wire is crimped, and as a result, serious accident in quality may occur.

(2) Insulation barrel

This is a barrel to caulk the wire covering. It has a function to hold the wire so that the conductor cannot be broken at the wire barrel section when a load is applied to the wire.

(3) Lance

This plays a role of the locking device so that the contact cannot be withdrawn from the housing when the contact is inserted into the housing (insulation case).

If the lance is deformed, the locking device does not function after the contact is inserted into the housing. As a result, the contact may be withdrawn from the housing or a given fixed force may not be obtained.

(4) Bell mouth

This is set in order to prevent the wire break at the end face of the barrel and to stabilize the tensile force at the crimping part.

(5) Serration

There is a case that a dimple of parallel or cross knurl is set on the inside of the wire barrel. This is called "Serration".

Serration promotes the destruction of the oxide film on the barrel face and the conductor at the time of crimping and aims for more electrically stabilizing the connection.

(6) Contact section

A section to allow electrical connection with a mating contact when the female and male of the connectors are engaged with each other.

## 3-2. Stripping of wire covering

### 3-2-1. Suitability of the stripping length

Stripping length of the wire is specified for each contact. The quality of working property of crimping depends on the accuracy of finishing of the stripping length. So, be careful.

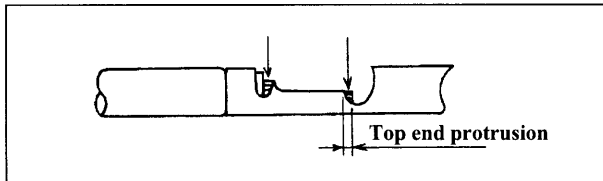

When crimping is performed, the conductor should protrude from the top end of the wire barrel, and the covering should not be pulled in the insulation barrel or not be entered inside the wire barrel.

### 3-2-2. Wire stripped condition

- (1) Conductor should be free from any damage or partially broken or missing wires.
- (2) Length of the conductor or cut-off end face of the covering should not be irregular nor loosened.

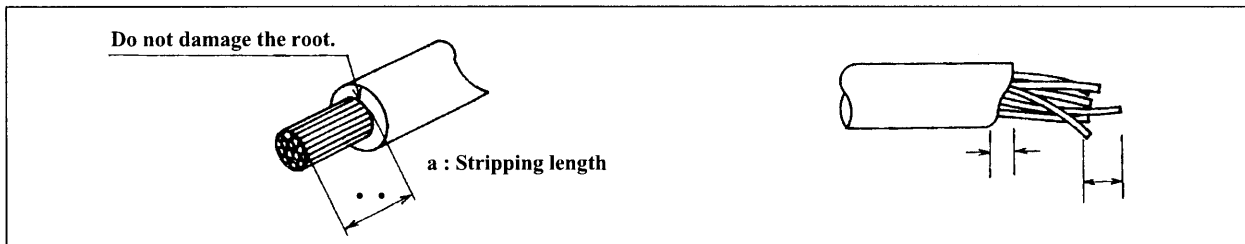

## 3-3. Bell mouth

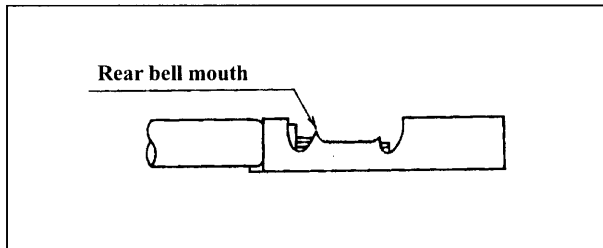

Check to be sure that the contact that has been crimped is provided with a bell mouth at the rear.

Size of the bell mouth varies according to different contacts.

If the bell mouth is excessively small, there is a danger of wire break of the conductor at the end face of the wire barrel or shortage of the tensile strength at the crimped section.

## 3-4. Crimp height

Crimp height is an essential factor in determining the crimping quality of the crimped contact.

If the crimp height is out of the standard, there is a danger of causing a serious accident.

In case of the manual crimping tool, even when the wire is in the range of the applicable wire for the contact, there is a case where the tool is not applicable to the wire used. So, be careful.

### 3-4-1. Measuring the crimp height

Use the micrometer for measuring the crimp height to measure the crimp height.

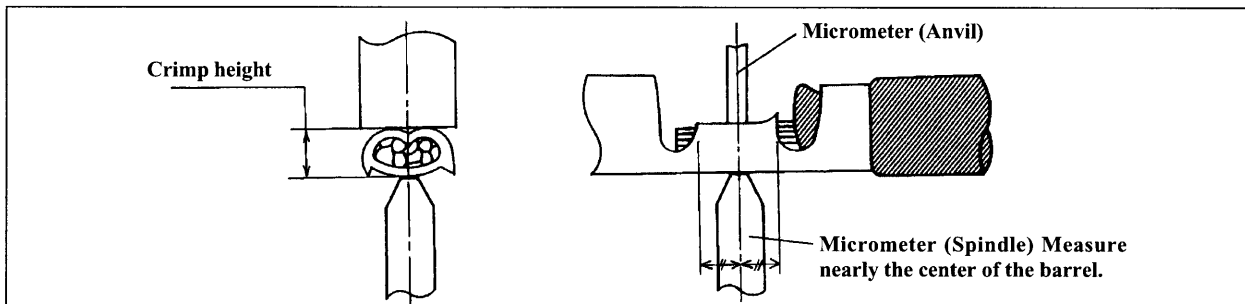

### 3-5. Tensile strength of crimped section and measuring method

#### 3-5-1. Tensile strength of crimped section

This is the strength that can be endured when the wire conductor that has been crimped (wire barrel section) is pulled. Tolerance value is set to each contact and each wire.

#### 3-5-2. Testing method of tensile strength

Crimp a wire having a little larger stripping length so that the insulation barrel does not function, and install it on the tension tester to measure the value at which the wire is broken. (Set the pulling speed of the wire at 20mm to 80mm/min.)

### 3-6. Confirmation of the shape of contact after crimping

#### 3-6-1. Standard of good products

- (1) The crimp height is in the range of standards.
- (2) The bell mouth has an appropriate size.
- (3) The protrusion of the conductor is proper.
- (4) The covering is not (deeply) pressed into the wire barrel.
- (5) The covering is properly crimped onto the insulation barrel.
- (6) The conductor is not protruded from the wire barrel.
- (7) The contact section of the contact is not deformed.
- (8) The lance is not deformed.
- (9) The wire barrel has no noticeable burr.
- (10) The crimped section is free from any crack or rough barrel outside surface.
- (11) The contact is not significantly bent.

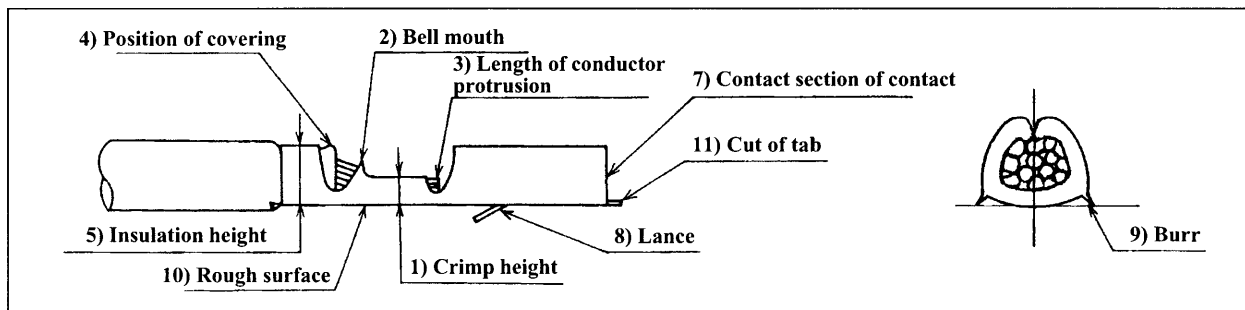

#### 3-6-2. Example of defective crimping

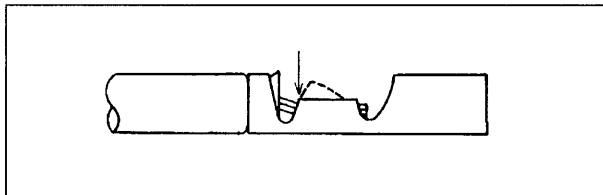

- (1) No or excessive bell mouth

This may occur because of adjustment condition of the tool or setting of the contact to the tool. There is a danger of wire break of the conductor, shortage of tensile strength or unsteady state of electrical connection since there is no bell mouth or an excessive bell mouth.

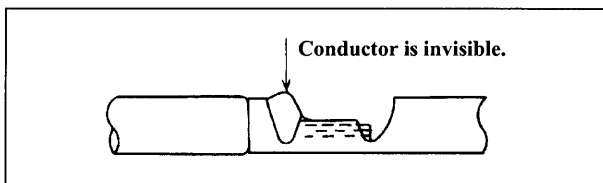

- (2) Deep indentation

This may occur when the stripping dimensions of wire or setting of the wire to the tool is improper.

There is a danger of wire break of the conductor by the deep indentation.

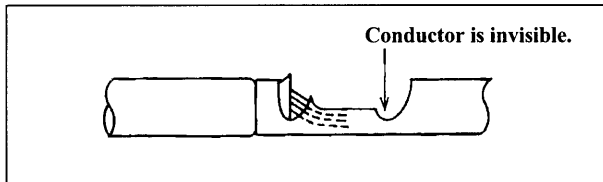

- (3) Insufficient insertion of conductor  
 This may occur when the stripping dimensions of wire is improper.  
 There is a danger of the shortage of tensile strength or unsteady state of electrical connection because of the insufficient insertion of the conductor.

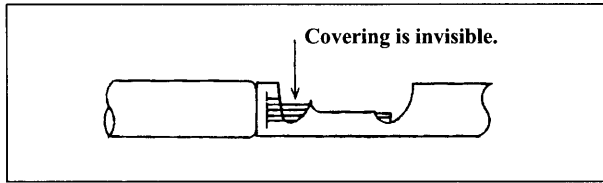

- (4) Poor pressing  
 This may occur when the stripping dimensions of the wire is improper.  
 There is a danger of wire break since the load applied to the wire is directly transmitted to the crimped section of the conductor by the poor pressing.

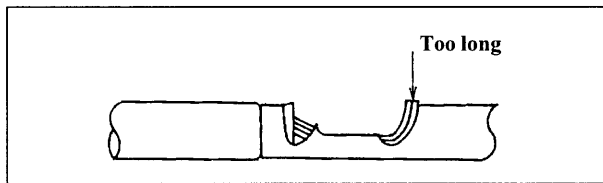

- (5) Protrusion of the conductor is too long.  
 This may occur when the stripping dimensions of the wire or setting of the wire to the tool is improper. There is a danger of contact trouble of the contact or insufficient insertion into the housing since the protrusion of the conductor is too long.

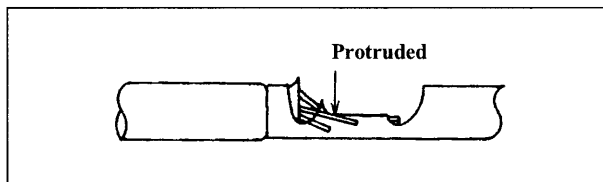

- (6) Protruded conductor  
 This may occur when the wire, the conductor of which is loosened is used. There is a danger of the unsteady state of electrical connection or shortage of tensile strength because of the protruded conductor.

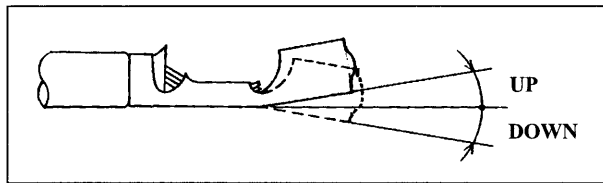

- (7) Deformed contact (Bent UP/DOWN)  
 This may occur by the adjustment condition or wear of the tool, setting condition of the contact in the tool, or handling of the contact. If the bent UP/DOWN is excessive, insertion of the contact into the housing may not be performed.

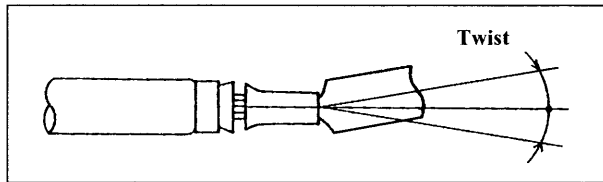

- (8) Deformed contact (Twist)  
 This may occur by the adjustment condition of the tool, setting condition of the contact in the tool, or handling of the contact. If the twist is excessive, insertion of the contact into the housing may not be performed.

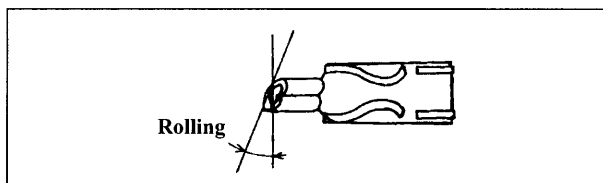

- (9) Deformed contact (Rolling)  
 This may occur by the adjustment condition of the tool, wear of blade edge, setting condition of the contact in the tool or handling of the contact. If the rolling is excessive, insertion of the contact into the housing may not be performed.

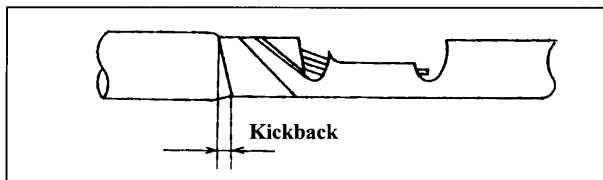

- (10) Deformed insulation barrel (Kickback)  
 This may occur when the wire that is not applicable to the tool is used.  
 If the kickback is excessive, there may be a problem of pressure resistance since the contact is exposed from the housing after the contact has been inserted into the housing.



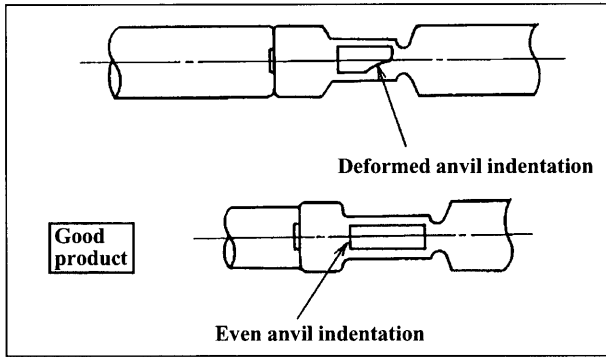

(11) Uneven anvil indentation

This may occur by the wear of anvil or the like.  
If the anvil indentation is uneven, there may be an unsteady state of electrical contact.

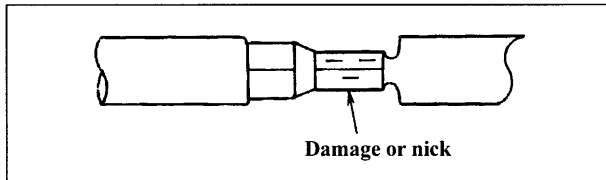

(12) Damaged or nicked crimped face

This may occur when there is a damage or wear on the crimper.  
If there is a damage or nick on the crimped face, deformation of the contact, peeling of coatings, etc. may occur.

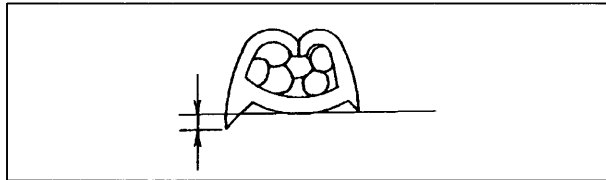

(13) Too large or irregular crimping burr

This may occur because of the adjustment condition of the tool, or wear or damage on the crimper or anvil. There is a danger of crack on the contact at the burr section, unsteady state of electrical connection, shortage of tensile strength, or deformation of the contact since the burr is excessive, or right- and left-hand sides of the contact are not even.

### 3-7. Insertion of contact into housing

#### 3-7-1. Checking of lance height

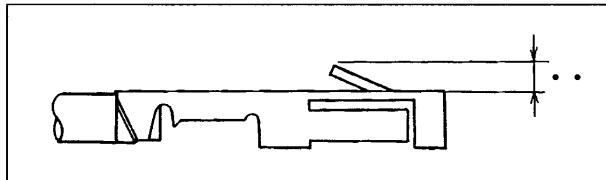

Check to be sure that the lance height of the crimped contact is in the range of the specified dimensions.

#### 3-7-2. Assembling procedure (example)

- (1) Hold a part of the wire which is located within 10 cm from the contact and insert it into the housing.
- (2) Insert the contact into the housing so that the contact should be levelled to the housing.
- (3) Do not interrupt inserting the contact when performing the insertion and completely perform the insertion until the lance is engaged. There are a sound of "snap" and response when the lance is properly engaged.

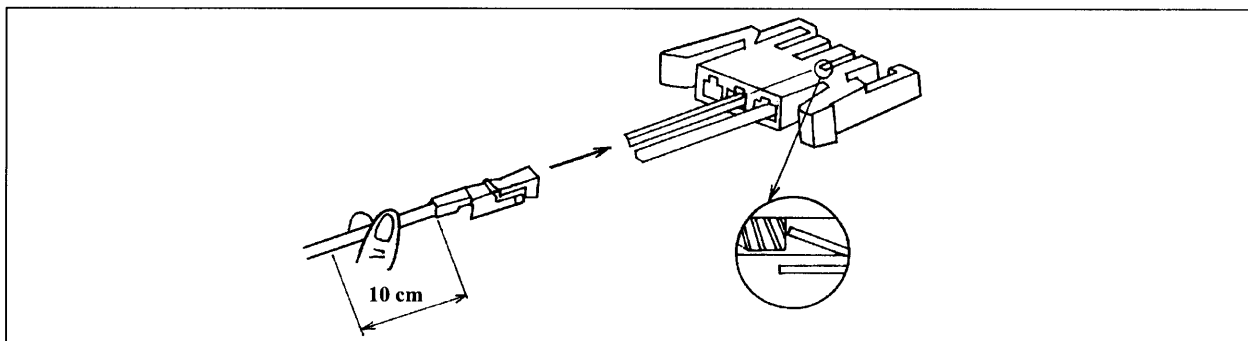

### 3-7-3. Checking the assembly condition of the housing

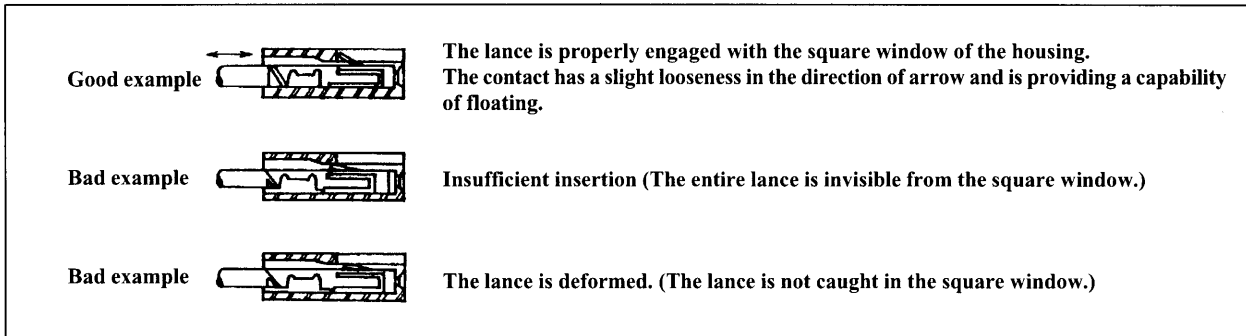

### 3-7-4. Drawing out the contact

Drawing out the contact from the housing varies in accordance with the connectors. Exclusive jigs for drawing out the contact are prepared for some tools. For details, check the catalogue for connectors.

### 3-7-5. Checking after assembly

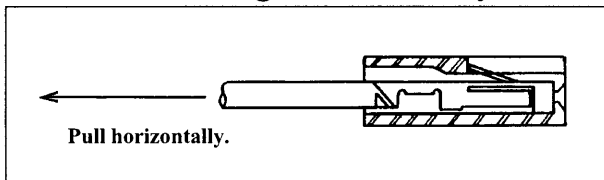

- (1) Check to be sure that the contact is correctly assembled into the housing.
- (2) Slightly pull the wire by hand and check to be sure that the contact cannot be pulled out.

## 3-8. Other precautions

### 3-8-1. Precautions when tying the wire

Make an allowance for the wire when tying the wire so that an extra load is not applied to the contact.

When tying both ends of the wire, be careful that any load is not applied to the contact on which the wire is tied first.

### 3-8-2. Continuity pressure resistance check

When performing the electrical test for the tied wire, perform the test in a state that the wire is fit for the connector on the receiving side.

If foreign material is inserted into the contact section of the contact, the contact section is deformed. As a result, there is a danger of defective continuity.

### 3-8-3. Handling the contact

- (1) Do not touch the contact more frequently than minimum required opportunity.
- (2) When touching the contact, wear the gloves or the like to prevent the contact from corrosion.
- (3) Do not roughly handle the contact. The contact is deformed if any thing is placed on the contact or the contact is dropped.
- (4) Do not forcibly pull the contact when it is entangled. Disentangle it with care to prevent it from possible deformation.
- (5) Lightly pick up the contact when picking it up. Do not pick up the lance, contact section, etc. which are easily deformed.
- (6) Be careful so that the respective contacts of the wires that have been crimped should not be entangled with each other.

In case tying or overlapping the crimped wires, be careful that external force should not be applied to the contacts.

- (7) Keep the contact in a polyvinyl bag or the like to prevent it from corrosion.

## 4. Configuration of tools

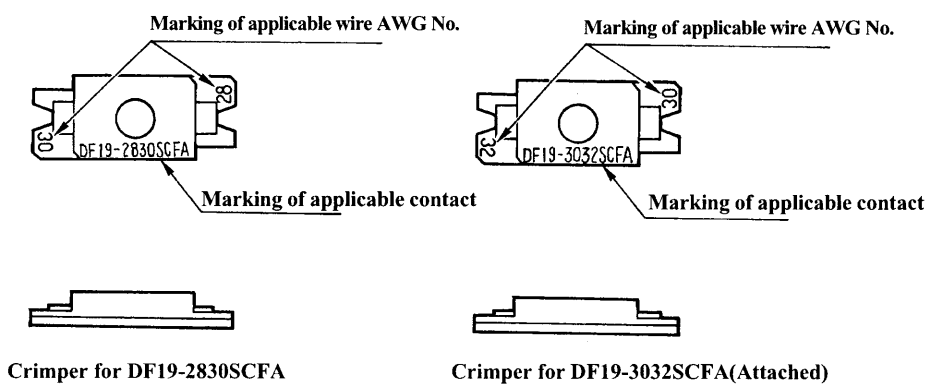
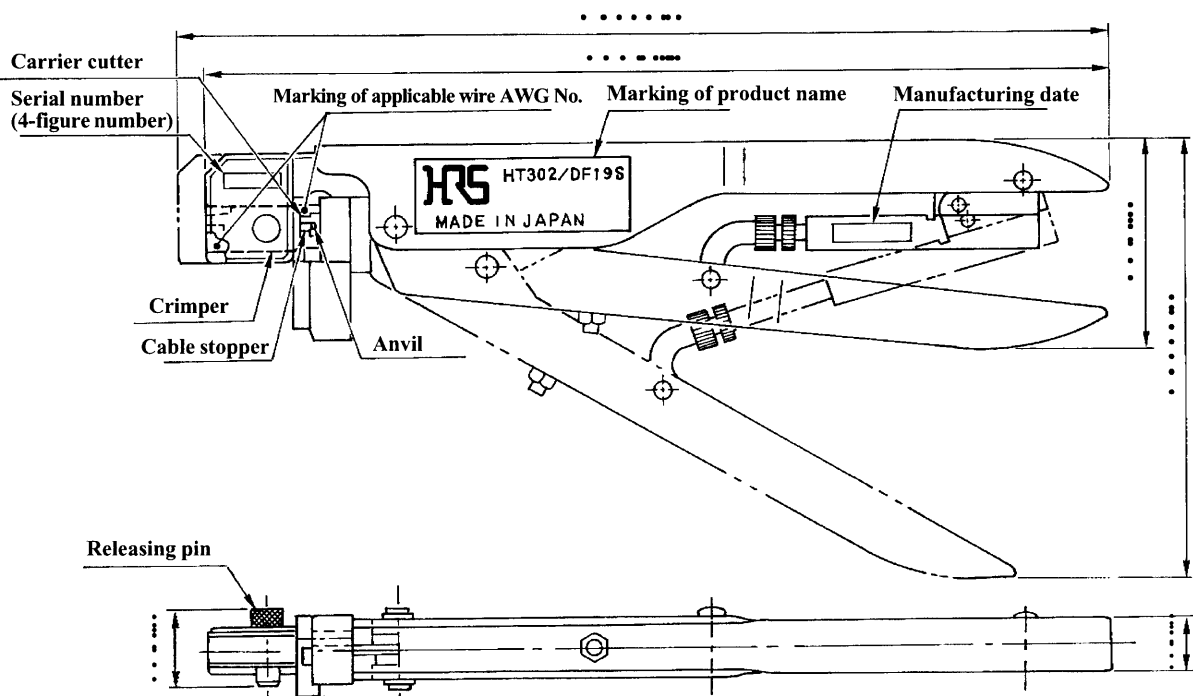

## 5. Applicable contacts and applicable wire

Applicable contact	Applicable wire			
	UL STYLE No.	AWG No.	Structure of contact wire	Outside diameter of covering
DF19-2830SCFA	1571	28	7 / $\phi$ 0.127	$\phi$ 0.58
	1571	30	7 / $\phi$ 0.102	$\phi$ 0.56
DF19-3032SCFA	1571	30	7 / $\phi$ 0.102	$\phi$ 0.56
	1571	32	7 / $\phi$ 0.08	$\phi$ 0.54

## 6. Operating procedure

### 6-1 Matching the crimper to the cable size

This tool has exclusive crimpers in accordance with the applicable contacts ; one part is exclusive for DF19-2830SCFA and the other exclusive for DF19-3032SCFA (2 parts in total). Replace the crimper in accordance with the contact and the wire to be used. (The anvil is shared by both crimpers.)

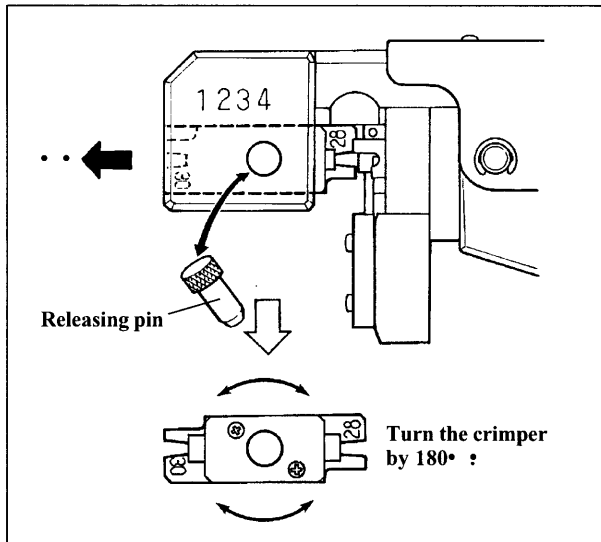

#### ■ How to replace the crimper

- (1) Draw out the releasing pin located at the crimping tool head section.
- (2) Draw out the crimper in the direction of the arrow mark A.
- (3) Turn the crimper by 180° and attach it on the head so that the inscription mark showing the size of the cable used can be observed and insert the releasing pin.

### 6-2. Operating procedure



#### CAUTION

To prevent the hands from being damaged during operation, do not place the fingers between the handles or crimping portion.

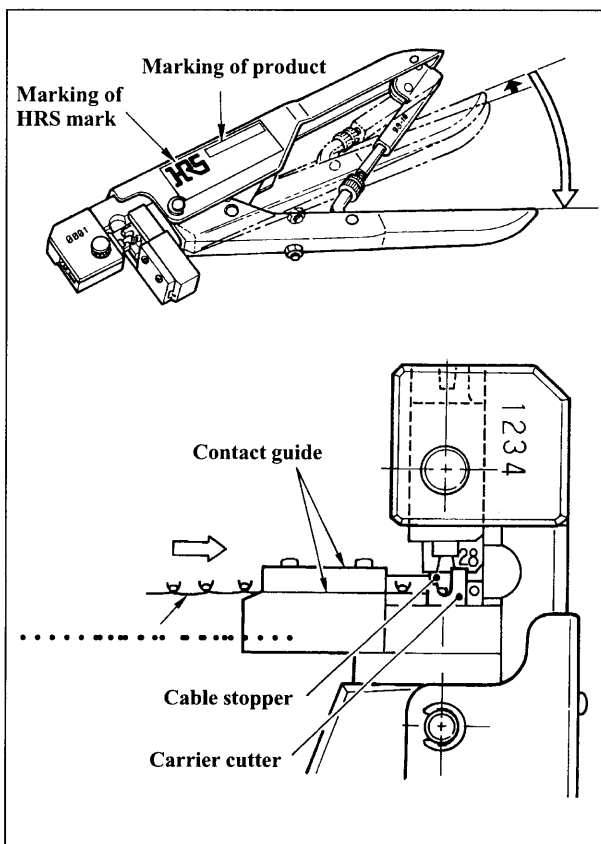

- (1) Hold the tool with its side on which HRS mark and product name faced upward.
- (2) Grasp the handle far enough until the ratchet becomes disengaged, and then fully open the handle.
- (3) Place the contact on the anvil and insert it into the contact holder until it comes in contact with the stopper in the contact holder.

- **Caution** • The deformed contact cannot be passed. Do not use it. When the contact is passed, there is a response of "click". The position where there is a response of "click" when the contact comes on the anvil is the crimping position.

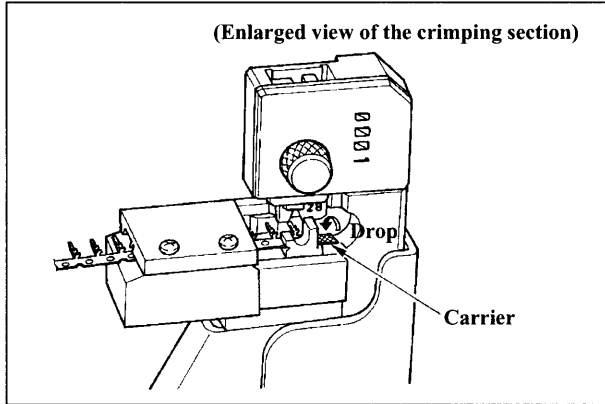
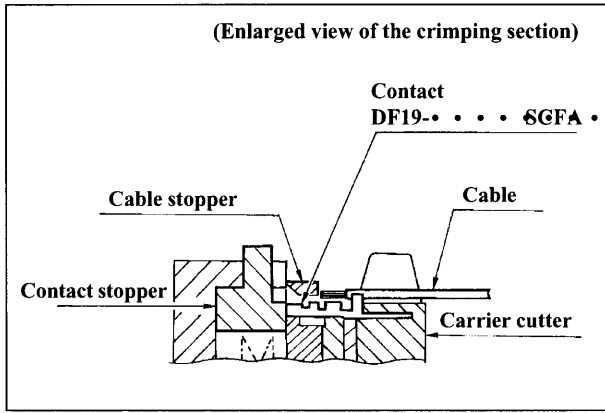

(4) Strip the covering of the cable by a given length. Then match the cable to the position of contact while taking care not to allow the contact wire to loosen.

(Refer to Paragraph 7-2 in "Crimping quality standard" on page 11 for the stripping dimensions.)

**(Caution) Do not press the contact directly with the cable since there is a possibility of defective crimping.**

(5) Grab the handle by hand until the ratchet is released.

**(Caution) The carrier is cut at the same time of crimping. Be careful that the cut carrier does not enter inside the tool. When the operation is performed while foreign materials such as the carrier and the like are inside the tool, there is a possibility of tool breakage or defective crimping.**

(6) Grab the handle by hand until the ratchet is released and the handle is opened.

(7) Draw out the crimped contact while holding the cable.

**• • Caution) Be careful not to allow the contact to hit against the cable stopper, etc. to deform.**

(8) Check to be sure that the crimping has been made normally.

(Refer to the crimping conditions and the crimping quality standard on page 10 and page 11.)

## 7. Crimping conditions and crimping quality standard

### 7-1. Crimping conditions

Check to be sure that the contact that has been crimped using the tool satisfies the following standards with respect to the crimp height and the tensile strength.

Applicable contact	Applicable wire				Crimp height on contact wire side	Crimp height on covering side	Tensile strength
	UL No.	AWG No.	Structure of contact wire	Outside diameter of covering			
DF19-2830SCFA	1571	28	7/∅ 0.127	∅ 0.58	0.52 • ∅0.56	0.65 • ∅0.84	10N or more
	1571	30	7/∅ 0.102	∅ 0.56	0.48 • ∅0.52	0.65 • ∅0.84	8N or more
DF19-3032SCFA	1571	30	7/∅ 0.102	∅ 0.56	0.42 • ∅0.48	0.65 • ∅0.84	8N or more
	1571	32	7/∅ 0.08	∅ 0.54	0.40 • ∅0.44	0.65 • ∅0.84	5N or more

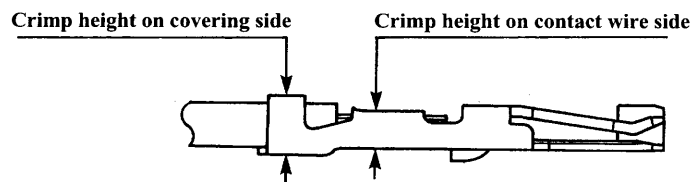

Instruction Manual Number	
TAD-P6619	
Date of issue	July 2000
Date of revision	
Edition number	First edition

## CAUTION

- (1) No part of this manual may be reproduced without the permission of Hirose Electric Co., Ltd.
- (2) Description in this manual is subject to change without notice.
- (3) This Instruction Manual has been prepared for clarify. Should you find any unclear portion, error, or omission, please, for the safety of other, contact our Marketing Department.
- (4) It should be understood that, notwithstanding the aforementioned item (3), we assume no liability to any claim for loss or failure to earn profit resulting from the use of the machine.
- (5) We assume no responsibility for any damage resulting from your improper use of the machine including your failure to follow the instructions given in this Instruction Manual. This includes repair or modification conducted by any third party other than Hirose Electric Co., Ltd.
- (6) Please note that servicing of the machine is not available in any country other than Japan.



**HRS**<sub>R</sub>

**HIROSE ELECTRIC CO.,LTD.**

5-23, OSAKI 5-CHOME, SHINAGAWA-KU, TOKYO 141-8587, JAPAN  
 TELEX: J2468237 HRSELE TELE FAX: 03-3493-2933  
 CABLE: BESELECONHIROSE TOKYO, PHONE: 03-3491-9741

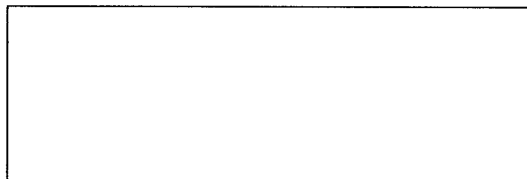

<b>Hirose Electric (U.S.A.), Inc.</b>	2688 Westhills Court, Simi Valley, Calif. 93065-6235	Phone : (805) 5227958 Tele-Fax : (805) 5223217
<b>Hirose Electric GmbH</b>	Zeppelinstraze 42 73760 Ostfildern-Kemnat	Phone : 0711-4560021 Tele-Fax : 0711-4560729
<b>Hirose Electric UK Ltd.</b>	Crownhill Business Centre, 22, Vincent Avenue, Crownhill, Milton Keynes, MK8 0AB	Phone : (0908) 260616 Tele-Fax : (0908) 563309
<b>HIROSE KOREA Co., Ltd.</b>	472-5, Mok Nae-Dong, Ansen-City Seoul	Phone : (02) 864-5075 Tele-Fax : (0345) 491-9886
<b>Hirose Electric Co., Ltd., Hong Kong Branch</b>	2102 Emperor Group Center, 288 Hennessy Road, Wanchai	Phone : 2803-5338 Tele-Fax : 2591-6560