

Introduction

The STEVAL-IHT001V2 thermostat kit ([Figure 1](#)) provides a robust and low-cost solution from STMicroelectronics using a microcontroller and AC switches to control a refrigerator, a freezer or a fridge/freezer combination. The firmware embeds three different thermostat control versions: basic (just for compressor and light control), defrost (with defrost resistor control added) and air circulation (with fan control added). This allows a wide section of the cold appliances market to be addressed.

The STEVAL-IHT001V2 board controls a single-phase induction motor and a light bulb, and, optionally, a defrost resistor and a fan, operating on 220/240 V RMS 50/60 Hz mains voltage. The thermostat kit is operational with 100/120 V RMS 50/60 Hz but a supply capacitor must be chosen for a 30 mA output DC current (see [Appendix H](#)).

The board can operate over an ambient temperature range of 0 to 60 °C. The exact maximum temperature depends on the power of the loads ([Section 3.2](#)).

Figure 1. STEVAL-IHT001V2 board

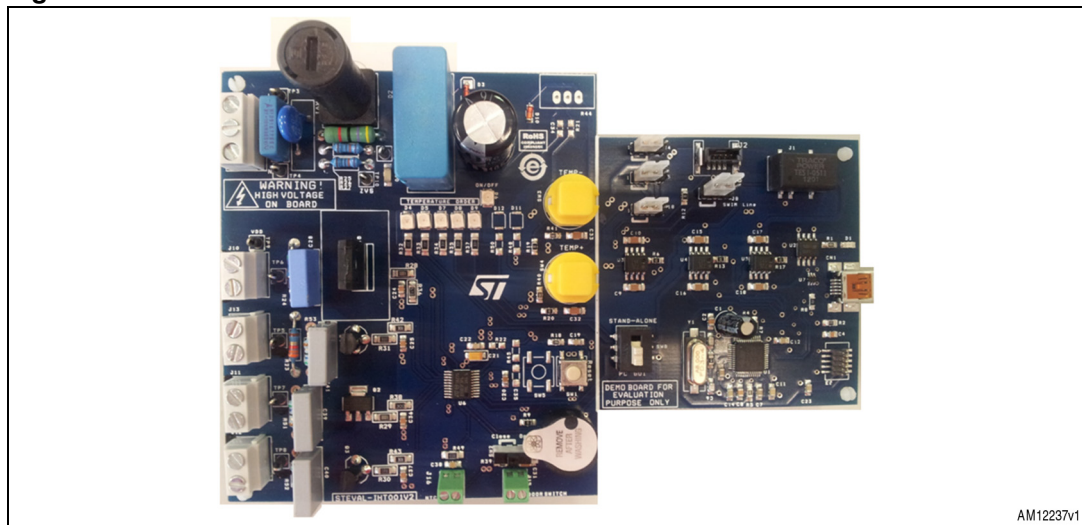

For demonstration and application development purposes a graphical user interface (GUI) has been developed. The PC and STM8 microcontroller, the MCU performing thermostat regulation, are connected through a USB bus. Since the STM8 MCU is a low-cost MCU not embedding a USB peripheral, a supplementary STM32 MCU has been added as a bridge between the PC and STM8 MCU, only in order to allow communication through the GUI.

The GUI is not only used to configure the thermostat (basic, defrost, air circulation), but also allows control parameters to be set and parameters measured during tests to be obtained ([Section 3.6](#)). This document provides users with all the information needed to get started with and operate the STEVAL-IHT001V2 thermostat kit. For detailed information on how to access the MCU in order to modify/measure parameters, please refer to the “Help” menu of the GUI software.

Contents

- 1 Kit introduction 6**
 - 1.1 Package contents 6
 - 1.2 Board presentation 6

- 2 Functional description 8**
 - 2.1 Performance 8
 - 2.2 Ensured functions 8
 - 2.2.1 Temperature control 8
 - 2.2.2 Compressor control 10
 - 2.2.3 Light bulb and buzzer control 10
 - 2.2.4 Defrost resistor and fan control 10
 - 2.3 Hardware features 11
 - 2.3.1 ACS and ACST devices 11
 - 2.3.2 STM8S003 microcontroller 12
 - 2.3.3 Control side and communication side power supplies 12
 - 2.3.4 STM32F103 microcontroller 12
 - 2.4 Graphic user interface (GUI) 12

- 3 Using the STEVAL-IHT001V2 thermostat kit 14**
 - 3.1 Thermostat versions 14
 - 3.2 Loads power 14
 - 3.3 Measure points 15
 - 3.4 Pulse control 15
 - 3.5 Getting started 17
 - 3.5.1 Jumper configuration for standalone or PC-driven modes 17
 - 3.5.2 Getting started 18
 - 3.5.3 Operating modes 19
 - 3.5.4 Instructions for the GUI software 20
 - 3.6 GUI windows description 20
 - 3.6.1 Temperature control tab 20
 - 3.6.2 Timing control tab 21
 - 3.6.3 Force debug 22
 - 3.6.4 Parameter measurements 22

3.6.5	Saving data	23
4	Conclusion	24
Appendix A	Thermal sensor linearization	25
Appendix B	Schematics	27
Appendix C	Additional pads	31
Appendix D	Bill of materials	32
Appendix E	Procedure to apply IEC 61000-4-4 burst test	36
Appendix F	STM8 program debugging	38
Appendix G	PC interface parameters description	40
Appendix H	Capacitor value according to country	41
	Revision history	42

List of figures

Figure 1.	STEVAL-IHT001V2 board	1
Figure 2.	Board details	6
Figure 3.	Hysteresis law	9
Figure 4.	Defrost control	11
Figure 5.	Placement of test points	15
Figure 6.	Timing definition for gate current pulses	16
Figure 7.	GUI - temperature control tab	21
Figure 8.	GUI - timing control window	21
Figure 9.	GUI - debug mode frame	22
Figure 10.	Linear voltage in function of the NTC resistor (for a 5 V power supply)	26
Figure 11.	Control side schematic	27
Figure 12.	Control side schematic - STM8	28
Figure 13.	Interface side schematic	29
Figure 14.	Additional pads schematic	30
Figure 15.	Placement of additional pads	31
Figure 16.	Test setup	36
Figure 17.	General graph of a fast transient/burst	37

List of tables

Table 1.	ACS vs. TRIAC devices	11
Table 2.	List of test points	15
Table 3.	Allowable ranges for gate current pulses	16
Table 4.	Jumper default configuration in standalone or PC-driven operating mode	17
Table 5.	Operating mode selector	18
Table 6.	BOM	32
Table 7.	Jumper configuration in programming and debugging modes	38
Table 8.	PC interface parameters	40
Table 9.	C29 capacitor value according to the country	41
Table 10.	Document revision history	42

1 Kit introduction

1.1 Package contents

The following items are supplied in this package:

- A thermostat board (ref.: STEVAL-IHT001V2)
- An M2020 5k NTC from EPCOS (ref.: M2020/5k/A20)
- A CD-ROM, including product presentations and datasheets, user manual (this document), application notes, firmware and the GUI software.

1.2 Board presentation

The STEVAL-IHT001V2 thermostat kit board is ideally separated in two parts as shown in [Figure 2](#). All devices dedicated to thermostat control are placed on the left side (control side). All devices dedicated to communication with the PC are placed on the right side (interface side).

Figure 2. Board details

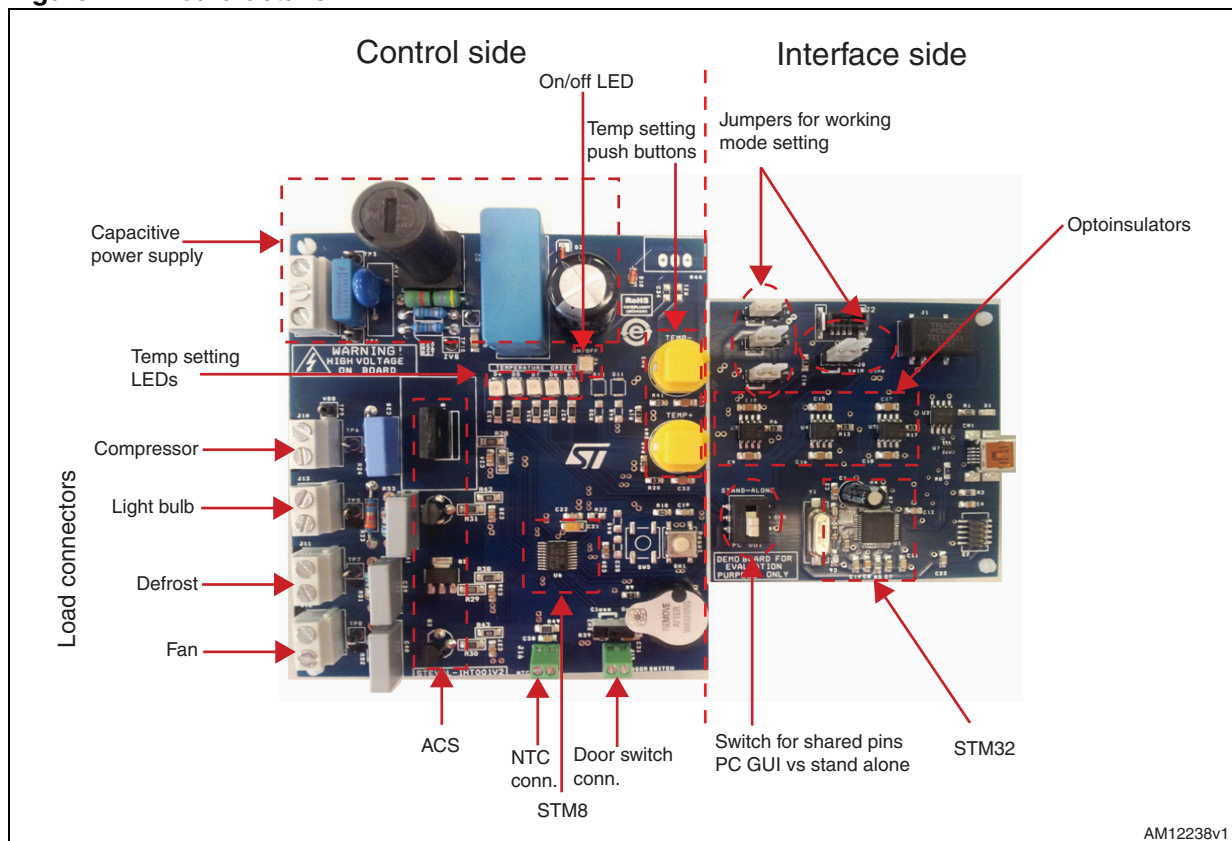

These two parts consist of (see [Appendix B](#) for the schematic):

- Control side:
 - Capacitive power supply, supplying only the control side of the board. The average output current of the capacitor power supply is about 25 mA with the embedded 1 μ F C29 capacitor (for a 230 V-50 Hz line RMS voltage)
 - STM8S003 microcontroller, low-cost MCU dedicated to thermostat control
 - AC switches: an ACST610-8FP, an ACS110-7SN and two ACS102-6TA, which control a compressor, a defrost resistor, a light bulb and a fan, respectively
 - One red ON/OFF LED. This LED turns ON when the board is powered
 - Five green LEDs for temperature set point visualization
 - Two push buttons to increase/decrease the temperature set point: Temp+ and Temp-
 - A buzzer to warn the user if the appliance door has been open for long time
 - Connectors for the NTC and door switch
 - One switch to simulate the door switch
- Interface side:
 - STM32F103 microcontroller to implement USB interface
 - Opto-insulators to implement safety insulation between the board and the computer to allow communication with the GUI when the board is plugged into the line voltage
 - DC/DC converter to supply the opto-couplers from the USB supply
 - Switches for standalone/PC-driven configuration (see [Section 3.5.1](#))
 - Mini-USB connector

The control side is independent from the interface side, i.e. control is ensured by powering on the control side only (in this case no GUI interfacing is allowed, of course).

Warning: Safety insulation is implemented between the board and the computer to allow GUI communication when the board is plugged into the line voltage, but the control side of the board is not electrically isolated from the AC input. The STM8 microcontroller is directly linked to the mains voltage. There is no insulation between the accessible parts and the high voltage. The STEVAL-IHT001V2 kit must be used with care and only by persons qualified for working with electricity at mains voltage levels. Any measurement equipment must be isolated from the mains before powering the board. To use an oscilloscope with the kit, it is safer to isolate it from the AC line. This prevents a shock from occurring as a result of touching any single point in the circuit, but does not prevent shocks when touching two or more points in the circuit.

2 Functional description

2.1 Performance

This board has been developed to fulfill the following requirements:

- Suitability for a wide range of cold appliances: this thermostat board can control the loads traditionally used in low, medium and high-end cold appliances - compressor, light, defrost resistor (if present), fan (if present).
- All AC loads are switched on at mains zero voltage, and operate in full-cycle conduction mode. This allows suppressing any EMI conduction noise.
- Electromagnetic compatibility: the board is able to withstand bursts up to 3.1 kV during IEC61000-4-4 standard tests without any operational problem. Surge tests have also been performed (IEC61000-4-5 standard) with bursts of 2 kV applied without any damage to the semiconductors.
- Compliance to safety standards: a 2 mm gap is ensured between all high-voltage and low-voltage parts (to obtain a functional level of isolation). The thermal sensor (NTC) is a class-2 sensor and can be put on non-earthed accessible and conductive parts.

The STEVAL-IHT001V2 kit provides added value in terms of:

- Low-cost solution for spark-free thermostat
 - No need for a sealed version
 - Low-cost STM8S microcontroller for thermostat control
 - Low-cost capacitive power supply
- Efficiency
 - Fridge consumption lowered by adjusting and reducing the hysteresis threshold of the temperature control (not easy with mechanical thermostats)
 - Improved efficiency by turning on the defrost resistor only when it's useful and not at each OFF cycle of the compressor (as done in some mechanical thermostats)
- Flexibility
 - Customization: program setting with PC interface to change firmware variables
 - Industrialization: end-of-production MCU programming thanks to FLASH, for soft upgrade and efficient MCU stock management

2.2 Ensured functions

2.2.1 Temperature control

For the thermal sensor, an insulated class-2 NTC resistor has been used. The part number is B57020M2502A020 from EPCOS which is commonly used for these applications. The value of this resistor increases when temperature decreases according to an exponential law. In order to linearize this relation, thus allowing an easier measurement, a series resistor has been added (see [Appendix A](#) for details).

The NTC must be placed on the evaporator of the fridge or the freezer. The controlled evaporator temperature should be in the range: [-40 to 10] °C.

Temperature regulation is achieved by hysteresis control (see [Figure 3](#)).

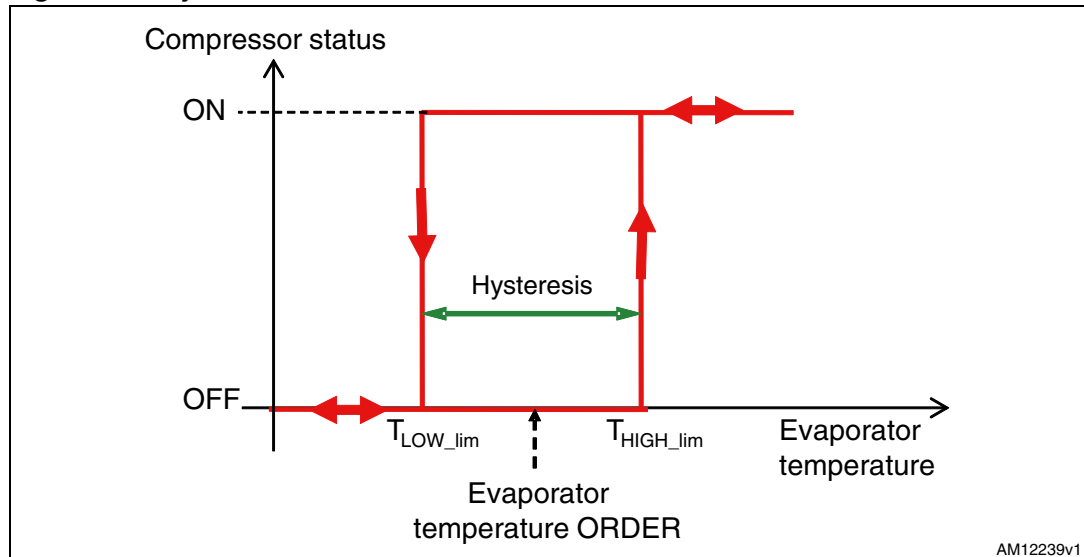
Figure 3. Hysteresis law

Five temperature set points have been implemented:

1. Very low
2. Low
3. Medium
4. High
5. Very high

For each temperature set point an evaporator temperature, a hysteresis, thus an upper limit and a lower limit are defined. T_{HIGH_lim} and T_{LOW_lim} are respectively the upper and the lower limits of the hysteresis and are defined as:

Equation 1

$$T_{HIGH_lim} = EvaporatorTemperature + \frac{Hysteresis}{2}$$

Equation 2

$$T_{LOW_lim} = EvaporatorTemperature - \frac{Hysteresis}{2}$$

The compressor is switched on if the sensed temperature is above T_{HIGH_lim} , and switched off when this temperature becomes lower than T_{LOW_lim} . When the door is open ([Section 2.2.3](#)), temperature control is not allowed, i.e. any action on TEMP+ and TEMP- has no effect. The temperature set point, or temperature order, can be set at one of the five levels by means of the two push buttons PB1 and PB2 (temperature setting push buttons) in standalone mode (see [Figure 2](#)) or by means of the GUI in PC-driven mode ([Section 3.6](#)), while the hysteresis value can only be changed using the GUI.

Five LEDs - D4, D5, D6, D8, D9 (temperature setting LEDs) ([Figure 2](#)) in standalone mode, or VL, L, M, H, VH in PC GUI driven mode ([Figure 7](#)) - turn on according to the temperature set point.

2.2.2 Compressor control

The ACST610-8FP device (referred to as Q1 in [Appendix B](#)) is used to turn on and off the compressor according to the evaporator temperature, sensed through the NTC resistor. Enough room around this AC switch has been left available to add a heatsink if needed.

2.2.3 Light bulb and buzzer control

The slider SW2 on the thermostat board has been placed on the board in order to simulate the fridge/freezer door. A light bulb is switched on or off according to the position of the door switch, open or closed respectively. The embedded switch may be replaced by an external switch using connector J15, in which case switch SW2 must be set in the “Open” position.

If the fridge door or the door switch remains in the open position more than one minute, the buzzer PZ1 sounds and the LEDs D4, D5, D7, D8, D9 flashes. The buzzer can be stopped by pressing the Temp+ or Temp- button once (the LEDs keeps on flashing while the door is in the open position). In the PC GUI driven mode the buzzer can be stopped with the GUI software (refer to the “Help” menu of the GUI). When the door is open, the temperature order can only be changed using the GUI software.

The light bulb is driven by the ACS102-6TA, Q4 on the thermostat board ([Appendix B](#)).

It should be noted that an R23 resistor has been added in series with Q4. Indeed, as the lamp lifetime ends, the filament breaks. The overall filament can be short-circuited by the flashover, and the load current is no longer limited. This current can exceed the i^2t capability of the ACS and destroy it (cf. AN1172). To avoid destroying the ACS102 at each lamp flashover, a power resistor is added in series with the light. This resistor is rated in order to limit the ACS current to its I_{TSM} value (10 A for a 10 ms half sinus conduction). In this case, a 33 Ω 1/2 W resistor is sufficient.

These resistor pads could be also used to put an inductor to limit the di/dt if a CFL/LED lamp is used in dimming mode.

2.2.4 Defrost resistor and fan control

Defrost resistor is controlled only when the thermostat is set to “Defrost” or to “air circulation” versions; while the fan is controlled only in the “air circulation” version.

The defrost resistor is driven by the ACS110-7SB2, Q2 on the thermostat board (see [Appendix B](#)).

This device is turned on following the “Defrost activation delay” parameter time defined in the GUI software. This time is compared to the sum of the compressor ACST ON times. When this sum is higher than the “Defrost activation delay”, defrost resistor ACST is enabled and then switched on as soon as the evaporator temperature is higher than T_{HIGH_lim} ([Figure 4](#)). It remains on during the “Defrost duration” time defined in the GUI software.

The conduction starts just before the conduction cycle of the compressor in order to reduce power consumption.

Figure 4. Defrost control

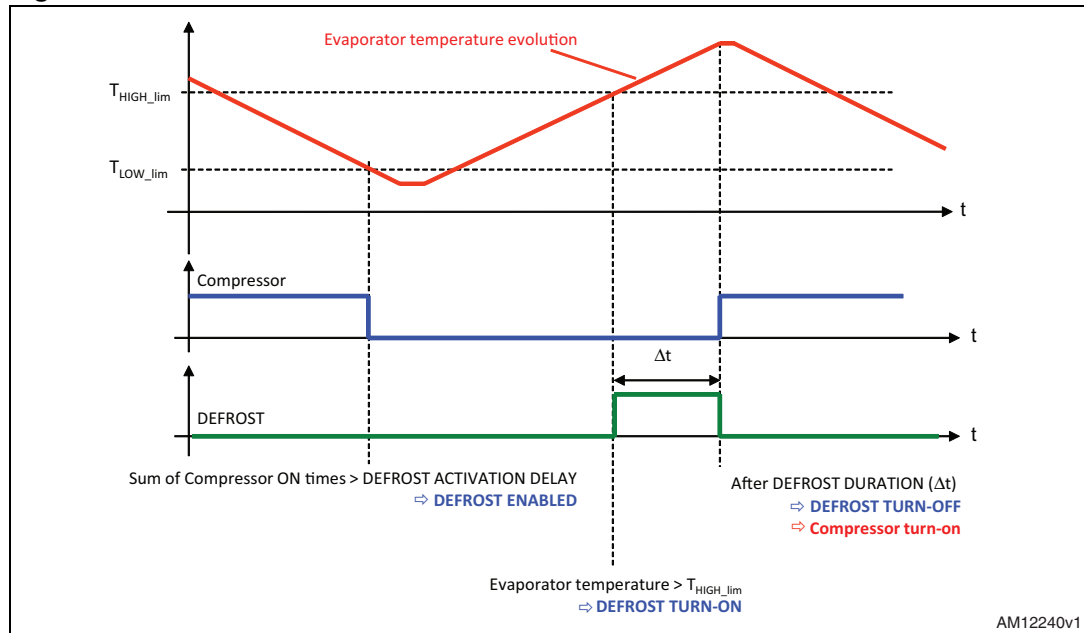

Fan control is only available in the “air circulation” fridge version. The fan is driven by the ACS102-6T, Q3 on the thermostat board ([Appendix B](#)).

The fan is on at the same time the compressor is on, except if the door is open (in that case the fan is turned off while the compressor is still running).

2.3 Hardware features

2.3.1 ACS and ACST devices

The STEVAL-IHT001V2 board embeds an ACST610-8FP, an ACS110-7SN, and two ACS102-6T. [Table 1](#) summarizes the main differences between ACS and ACST and traditional TRIACs.

Table 1. ACS vs. TRIAC devices

Device	Z0107	ACS102	Z0109	ACS110	BTA06-SW	ACST610
I _{gt} (mA)	5	5	10	10	10	10
Oversvoltage protection	No	Yes	No	Yes	No	Yes
(dV/dt)	20 V/μs	300 V/μs	50 V/μs	500 V/μs	40 V/μs	500 V/μs
(dI/dt) at turn-on	20 A/μs	50 A/μs	20 A/μs	50 A/μs	50 A/μs	100 A/μs

2.3.2 STM8S003 microcontroller

The MCU used in the thermostat kit is the STM8S003F3P6 belonging to the STM8S003 MCU family. It embeds a large number of features at minimum cost. This part number is used in order to minimize the number of pins. This causes some pins to be shared for different function recovery (LED3/SWIM_line, LED4/USART_CTS and LED5/USART_TX, [Figure 12](#)). The functions shared are functions dedicated to communication, i.e. no pin sharing in standalone mode. In order to further reduce costs, the internal oscillator has been used in order to generate the clock.

2.3.3 Control side and communication side power supplies

A capacitive power supply is used for the control side of the board. A 1 μ F capacitor, C29, has been chosen to supply the board - i.e. the control side of the board - with 25 mA, which is the maximum average current sunk by the control board (230 V-50 Hz line RMS voltage).

For more information about the design of the capacitive power supply, please refer to the application note AN1476.

In order to reduce the surge current, an R25 resistor is used in series with the C29 capacitor. Even if the power dissipation of this resistor is limited to $\frac{1}{2}$ W for a 30 mA output DC average current (for R25 = 47 Ω and 230 V line RMS voltage), a 2 W resistor has to be used on the board to sustain the inrush current.

One particularity of STEVAL-ITH001V2 board power supply is that it is “negative”. Indeed, the Vdd terminal is connected to neutral which means that the GND voltage is 5 V below neutral. This type of connection is mandatory to drive ACS devices. Indeed, ACSs can only be triggered by a negative current (i.e. sourced from the gate).

The communication side (with the STM32F103 microcontroller), is only supplied by the PC, by means of the USB connector, through the voltage regulator U2 (see [Appendix B](#)).

2.3.4 STM32F103 microcontroller

As for the connection between the PC and the STM8 microcontroller, a USB bus is used. Since the low-cost MCU dedicated to thermostat control does not embed a USB interface, a second MCU has been used to work as a gateway between the PC and the STM8. This MCU is an STM32F103C6, belonging to the STM32F103 family.

It is only used for demonstrative purposes, i.e. for communication in PC GUI driven mode.

2.4 Graphic user interface (GUI)

The graphical user interface (GUI) was developed in order to allow the user to set some control parameters, to configure the thermostat for the different versions (basic, defrost, air circulation), and to acquire variables during tests. The user can also choose to program the STM8 microcontroller with new control parameters.

The connection with the PC, using the USB interface, is ensured by the STM32 MCU embedding a USB peripheral.

The GUI provides the following features (refer to the “Help” menu of the GUI software for more information):

- Slide bars to change the MCU parameters (refer to [Figure 7](#) and [8](#)):
 - Temperature hysteresis
 - Evaporator temperature set point for each thermostat order
 - Gate current pulse widths and delays
 - Time before defrost activation and defrost duration
 - ZVS delay (synchronization of MCU commands with the mains voltage)
- Virtual knob to set the evaporator temperature level
- Virtual switch (“debug active”) to force the loads to on or off states (compressor, light, defrost, fan) for easier board validation
- Measurement and storage of several parameters during operation (duty cycle and running period of the compressor, evaporator temperature evolution, mains frequency and load status).

The most recently modified variables with the GUI can be stored for operation in standby mode.

It can be noted from [Figure 2](#) that the part of the PCB dedicated to the PC interface is clearly separated from that part of PCB dedicated to thermostat control in order to easily visualize the component count dedicated only to the thermostat application.

By means of opto-couplers, safety insulation is implemented between the board and the PC to allow communication with the GUI when the board is plugged into the line voltage. These opto-couplers, U3, U4, and U5 are supplied from the USB connector CN1 and the DC-DC converter J1 in order to not sink current from the capacitive power supply ([Appendix B](#)).

3 Using the STEVAL-IHT001V2 thermostat kit

3.1 Thermostat versions

The target market of the STEVAL-IHT001V2 kit is represented by low-end to high-end cold appliances, thus addressing a wide range of the COLD market. In particular, the MCU firmware is configurable to work in:

- Basic version: compressor and light bulb control
- Defrost version: compressor, light bulb and defrost resistor control
- Air circulation version (default): compressor, light bulb, defrost resistor and fan control

When the target thermostat is selected using the GUI, the gates associated with non-operating loads are no longer controlled, and remain uncontrolled even if the GUI is disconnected. To allow again fan or defrost heater control, the user has to re-program the STM8 MCU using the GUI.

3.2 Loads power

There is no heatsink mounted on the package of ACST610-8FP devices. In this case, the maximum permanent allowed current is 1.5 A RMS, for an ambient temperature lower than 40 °C (which is usually the highest operating temperature as the thermostat is either inside the fridge or outside on top, so at room temperature). If the ACST610-8FP must sink a higher current, or works at a higher temperature, a heatsink can be added. If its case temperature is kept below 92 °C, these devices can control a 6 A RMS current (as shown in Fig. 3 of the ACST6 datasheet). Refer to AN533 for further information on thermal management.

Refer also to AN1354 for more information on single-phase compressor control.

The ACS102-6T, in the TO-92 package, can withstand a 0.2 A RMS permanent current up to an ambient temperature of 100 °C. The ACS102-6T can drive the common light bulbs or fan found in the fridge or freezer without any problem. Indeed, a 25 W bulb always sinks a current lower than 150 mA and ACS102-6T can drive a maximum power fan of 40 W.

The ACS110 can drive a maximum 160 W defrost resistor for an ambient temperature lower than 40 °C. Indeed, the ACS110 cooling PCB pad of the thermostat kit demonstration board is cut down to the SOT223 tab size. As shown in fig. 2-2 of the ACS110-7SN datasheet, it can withstand a 1 A RMS permanent current up to an ambient temperature of 60 °C (with a copper surface of 5 cm² under the SOT223 tab) and can then drive a 200 W defrost resistor.

3.3 Measure points

Figure 5 shows where the test points are placed on the board, while Table 2 gives the definitions of the measurement points.

Figure 5. Placement of test points

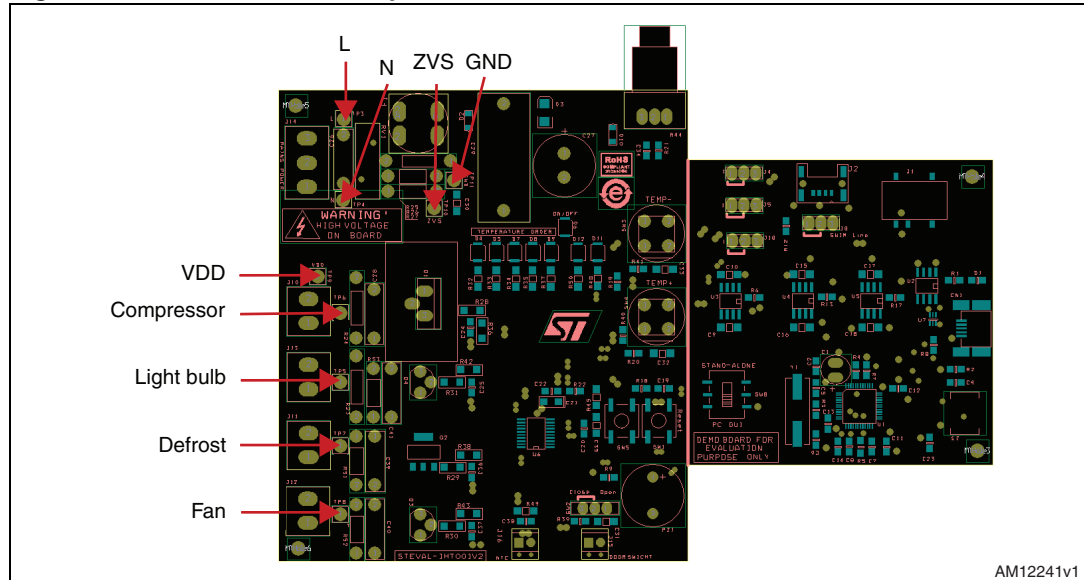

AM12241v1

Table 2. List of test points

Name	Description
L	Line
N	Neutral
VDD	+5 V - non-insulated power supply (also connected to ACS/ACST cathodes)
GND	GND - non-insulated power supply
ZVS	Zero-voltage signal at STM8 input
TP5	OUT pin of the ACS102 (light bulb)
TP6	OUT pin of the ACST6 (compressor)
TP7	OUT pin of the ACS110 (defrost)
TP8	OUT pin of the ACS102 (fan)

3.4 Pulse control

All loads are controlled in full cycle mode by a pulsed gate current. The STM8 MCU senses both the mains rising and falling edges to synchronize the gate pulse with the mains voltage.

Figure 6 shows the different times useful to understand when the gate current pulses are applied for the four AC switches (Q1, Q2, Q3, Q4):

- T1 is the mains voltage / compressor current phase shift. It helps to apply the gate current pulse just when the Q1 current reaches zero, in order to control the compressor

in full cycle mode. A higher delay could be applied to test the compressor in phase angle mode if required (for example to decrease the power dissipated by the compressor)

- T2 is the gate current pulse width for Q2 (defrost resistor)
- T3 is the gate current pulse width for Q1 (compressor)
- T4 is the mains voltage / fan current phase shift
- T5 is the gate current pulse width for Q3 (fan)
- T6 is the gate current pulse width for Q4 (light bulb)

Figure 6. Timing definition for gate current pulses

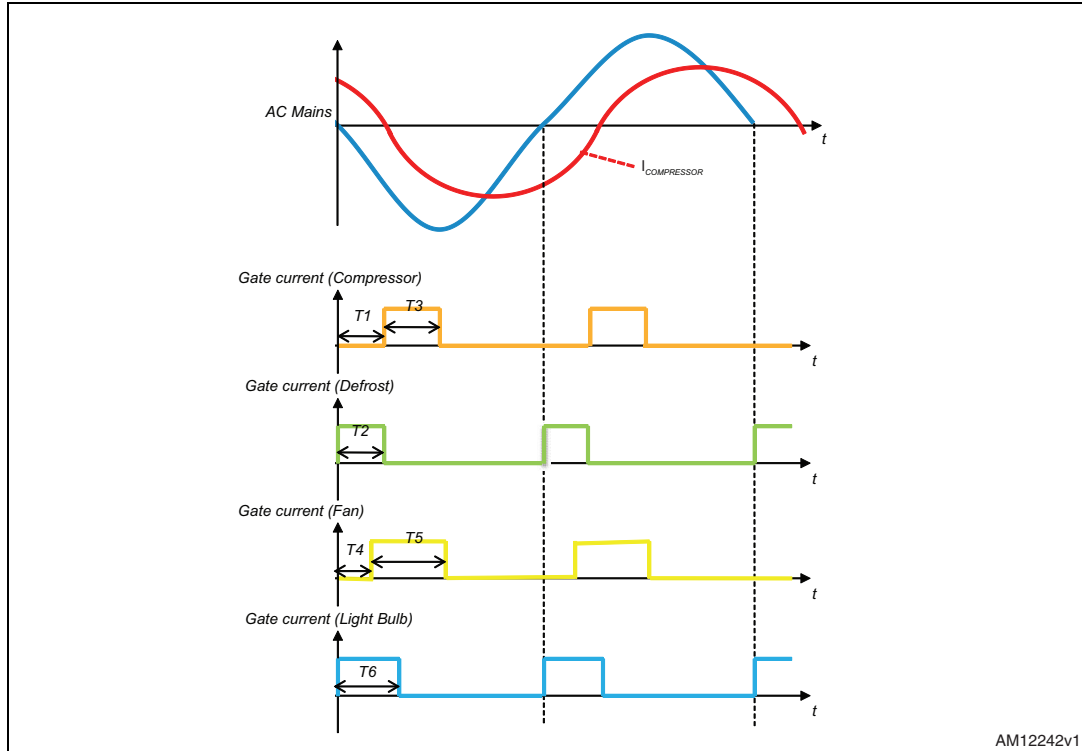

Gate current pulse delays and widths can be adjusted using the GUI in order to ensure the right control of loads, otherwise the default parameters shown in [Table 3](#) are used.

Table 3. Allowable ranges for gate current pulses

Parameter	Reference	Factory setting (ms)	Allowable range (ms)
Compressor phase shift	T1	0.5	0.1 to 5
Pulse width for defrost resistor control	T2	1	0.1 to 3
Pulse width for compressor control	T3	3	0.1 to 4
Fan phase shift	T4	0.5	0.1 to 5
Pulse width for fan	T5	2	0.1 to 3
Pulse width for light bulb control	T6	5	0.1 to 5

3.5 Getting started

3.5.1 Jumper configuration for standalone or PC-driven modes





The control side of the thermostat board is supplied by the capacitive power supply (refer to [Section 2.3.3](#)). As for the communication side, it is only supplied by the PC using the USB connector.

Default jumper positions are indicated in the silkscreen and in [Table 4](#).

Normally, the user must not move jumpers J4, J5, J8, J18 from the default position. They can be moved only by programming experts in order to modify STM8 firmware for specific purposes or adaptation to dedicated applications (refer to [Appendix F](#) for the procedure to follow).

Warning: Please take careful note of the jumper configuration given in [Table 4](#) before powering up the board, whatever the mode of operation. Incorrect jumper configuration with a non-insulated power source may result in damage to the PC.

Table 4. Jumper default configuration in standalone or PC-driven operating mode

Jumper	Mandatory configuration
J4	
J5	
J8	
J18	

In order to select the operating mode, switch SW8 must be set as shown in [Table 5](#). Please note that, once the thermostat board is operating, the operating mode cannot be changed. In order to change the mode of operation, the user must power off the board, move switch SW8 and power ON again ([Section 3.5.2](#)).

Table 5. Operating mode selector

	Operating mode		Description
	Standalone mode	PC-driven mode	
SW8	<p>STAND-ALONE PC-GUI</p>	<p>STAND-ALONE PC-GUI</p>	<p>PD5 PC7 LED5 Usart_TX_{STM8} LED4 Usart_CTS_{STM8}</p>

3.5.2 Getting started

To operate the STEVA-LIHT001V2 board correctly, follow the steps below given for each mode.

Standalone mode

1. Connect the NTC thermistor to the “NTC” connector on the thermostat board (control side)
2. Connect the DOOR switch (if an external door switch is going to be used) to the “DOOR SWITCH” connector on the thermostat board (control side), and set the door switch embedded on the board to the open position to allow the external switch to drive the door pin. Otherwise, if no external door switch is used, move the embedded one to the desired position: open or close. Note that when it is set in the open position, no temperature setting is allowed (except by using the GUI software in the PC-GUI driven mode). A closed position is required for temperature setting using the Temp+/Temp-push buttons.
3. Connect the loads on the thermostat board (see [Figure 2](#))
 - Compressor to “J10” connector
 - Defrost resistor to “J11” connector
 - Fan to “J12” connector
 - Indoor light bulb to “J13” connector.
4. Ensure that jumpers and switches are set as indicated in [Table 4](#) and [5](#).
5. Plug the mains wire into “MAINS” connector. Plug the mains wire into the mains voltage.
6. After a few seconds, during which the MCU setup operations and frequency measurement operation take place:
 - The “on/off” red LED turns on
 - The D7 LED turns on, indicating that medium temperature is set.
 - The compressor and fan switch on if the sensed temperature is above the temperature order (should be the case if the NTC is at ambient temperature).
 - The light bulb is switched on if the DOOR switch is in an open position, in which case the fan is switched off.
 - The LED D8 turns on for about a half second during the setup phase, then it is switched off.

PC GUI driven mode

1. Repeat steps 1 to 3 of “standalone mode”
2. Ensure that the jumpers and switches are set as indicated in [Table 4](#) and [5](#) (PC-driven mode)
3. Plug the USB connector into the PC
4. Plug the mains wire into the “MAINS POWER” connector. Plug the mains wire into the mains voltage.
5. After a few seconds during which the MCU setup operations and frequency measurement operation take place, a popup window indicating that the device has been recognized appears in the PC. As soon as the popup appears, it is possible to connect the thermostat board and the thermostat GUI software by pushing the virtual button “Connect”.

For troubleshooting issues in standalone mode, verify the following:

- If no LED is ON, check the jumpers (they have to be set as in [Table 4](#), standalone mode) or replace the fuse
- If the LEDs seem OK, reset the STM8 microcontroller using button SW1. Otherwise, unplug the board from the mains, discharge the VDD supply with a short-circuit between VDD and GND and plug the board back to the mains.

For troubleshooting issues in PC GUI driven mode, verify the following:

- Ensure that switch SW8 is in the “GUI MODE” position
- Check that the correct COM port is selected (refer to the GUI “Help” menu for details)
- Repeat the startup operation, in particular if mains voltage has been turned off, ensuring that the USB cable is plugged in before the mains wire is connected (i.e. the interface side must be powered on before the control side).
- If no popup appears in the PC, just wait a few seconds before connecting the GUI after the board has been powered ON.

3.5.3 Operating modes

When the board works in standalone mode, control parameters to be considered (pulses timings, temperatures, fridge version, etc.) are the last ones uploaded in the GUI. If no parameter has ever been uploaded, the default values are those shown in [Table 3](#), factory settings. In standalone mode, the temperature order is set by means of the two push buttons TEMP + and TEMP-, indicated by the five green LEDs (see [Figure 2](#)), and the AC loads are driven according to the order, to the sensed temperature and to the door switch.

In PC GUI mode, the user can upload the control parameters loaded in the STM8 MCU, check them and eventually modify them. Temperature order is no longer displayed using the 5 LEDs - D4, D5, D7, D8, D9 - but is displayed in the GUI only (virtual LEDs VL, L, M, H, VH). AC loads can be driven not only according to temperature, but their state can be forced by the GUI in debug mode (see [Section 3.6.3](#) for details).

The user can put the STM8 in halt mode by holding button SW3 “TEMP -” for 5 s. This low-power mode can be exited by a single push on SW4, “TEMP+” button. A beep warns at each halt mode enter/exit.

It should be noted that, since push buttons SW3 and SW4 are disabled when the door is open, the user cannot enter/exit halt mode if the DOOR switch SW2 (otherwise the external switch wired to connector J15) is in the open position.

3.5.4 Instructions for the GUI software

In order to use the GUI of the STEVAL-IHT001V2 kit, a recent version of Windows (starting from Windows XP with SP3) must be installed on the user's computer.

To install the PC software (GUI) tool:

- Put the companion CD-ROM into the PC
- Browse the CD-ROM directory to locate the GUI setup executable file
- Double-click on the GUI setup executable file
- Follow the instructions as they appear on the screen

An insulated interface is embedded in the board. By means of the STM32 MCU, the user is able to manage/monitor the control parameters of the thermostat.

For more details please refer to the GUI "Help" menu.

3.6 GUI windows description

3.6.1 Temperature control tab

Choosing one of the temperature orders is done using the "thermostat order" switch position on the GUI ([Figure 7](#)) or using the temp selector push buttons "TEMP+" and "TEMP-" on the board.

Note: If "Thermostat order" or "Led temperature" = VL, then "evaporator temperature order" = "evaporator temperature order 1 - Very Low"

If "Thermostat order" or "Led temperature" = L, then "evaporator temperature order" = "evaporator temperature order 2 - Low"

If "Thermostat order" or "Led temperature" = M, then "evaporator temperature order" = "evaporator temperature order 3 - Medium"

If "Thermostat order" or "Led temperature" = H, then "evaporator temperature order" = "evaporator temperature order 4 - High"

If "Thermostat order" or "Led temperature" = VH, then "evaporator temperature order" = "evaporator temperature order 5 - Very High"

The value of the five temperature orders and temperature hysteresis has to be set according to the appliance and the desired cabinet temperature for each operation. They is displayed through the five virtual LEDs shown in [Figure 7](#). Thermostat order, evaporators temperature orders and temperature hysteresis are sent and received by clicking on the "Set" or "Get" buttons, respectively. Note that the default evaporators temperature orders and temperature hysteresis are given in [Appendix G](#), and can be retrieved by clicking on the "Restore Default" push button.

Figure 7. GUI - temperature control tab

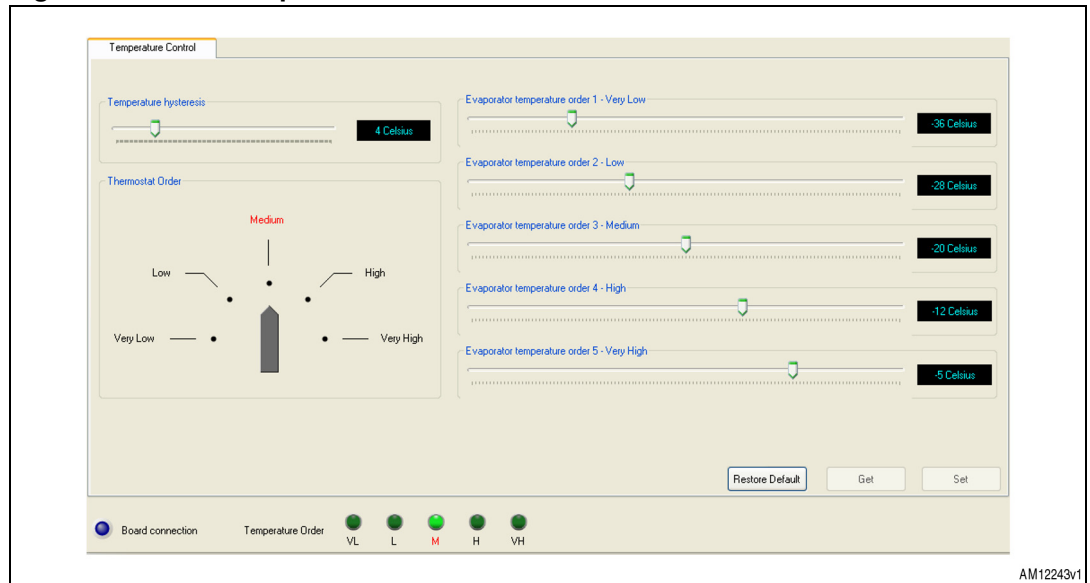

3.6.2 Timing control tab

This section (*Figure 8*) controls the gate current width for the AC switches, the delay to switch ON the AC switches Q1 (for compressor) and Q3 (for fan), the ZVS delay, the delay to activate defrost and the defrost duration. These parameters are sent and received by clicking on the “Set” or “Get” buttons, respectively. Note that the default parameters are given in *Appendix G*, and they can be retrieved by clicking on the “Restore Default” push button.

Figure 8. GUI - timing control window

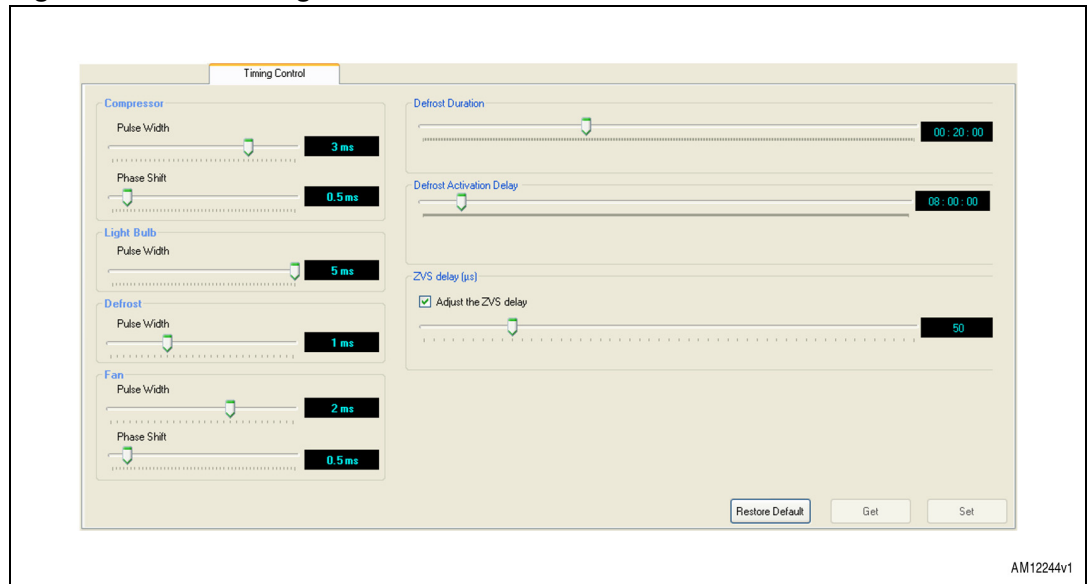

The ZVS delay is the delay between the AC mains zero voltage and the detection of this zero voltage by the MCU in order to synchronize the MCU orders with the AC mains voltage. The MCU uses the zero-voltage crossing (ZVC) events to synchronize the AC switches gate current pulses.

3.6.3 Force debug

A “force debug” is used to force the AC load state to the control state as defined by the MCU for easier board validation (*Figure 9*). In order to control the AC loads, it is necessary to click on the “Debug Active” button in the “Debug Mode” frame. In this case, the green lights of the AC load buttons are on if the associated loads are also on. Otherwise, the user can pre-select the load to be switched on, before clicking on the “Debug Active” push button, in which case the buttons corresponding to the pre-selected load become yellow, but this has no effect until the “Debug Active” button is pushed.

If the debug mode is active (“Debug” push button is lit), then:

- Clicking on the “Compressor/Fan” button turns on Q1 and Q3, i.e. the compressor and fan.
- Clicking on the “Light Bulb” button turns on Q4, and then the bulb lights up.
- Clicking on the “Defrost” button turns on Q2, and then the defrost resistor starts to heat.

Note: The defrost and compressor loads cannot be switched on at the same time. Setting defrost resets compressor, and vice-versa.

The light bulb and fan cannot be switched on at the same time. The fan switches off as soon as the light bulb switches on.

In order to go back to the “normal” mode, the user must click on the “Debug” button. In this case, all the virtual button green lights turn off.

Figure 9. GUI - debug mode frame

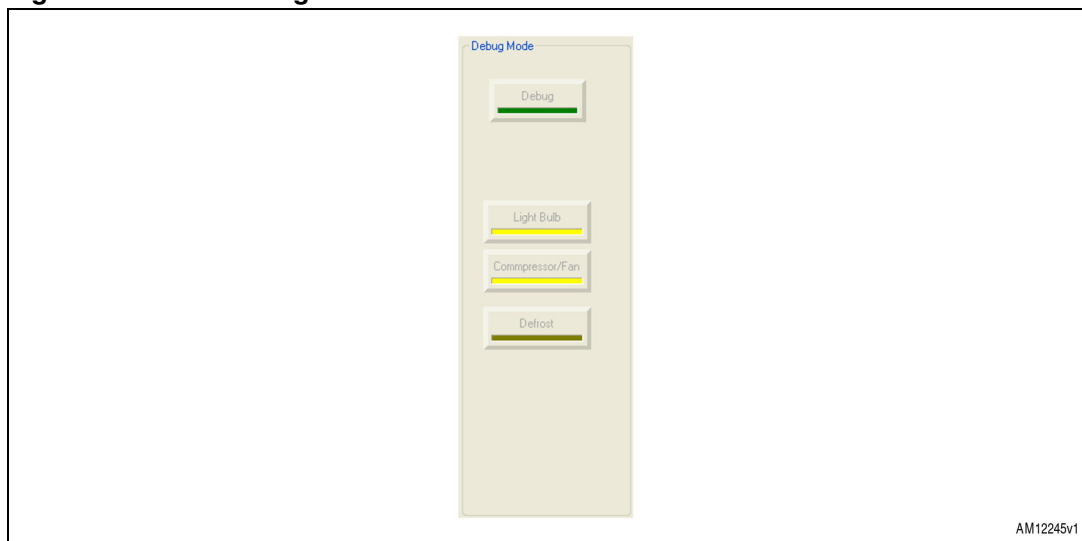

3.6.4 Parameter measurements

The GUI is able to get and display the different parameters from the MCU, like the temperature order, the evaporator temperature, the AC load state, the compressor cycle information (running period and duty cycle) and the mains frequency.

For more information refer to the “Help” menu of GUI software.

To enable real-time data acquisition, the user must push on the “Start Acquisition” button (refer to the “Help” menu of the GUI software for more information). The sampling frequency can be set in the “Options” window.

3.6.5 Saving data

The user can choose to update the STM8 MCU firmware with the timing and temperature parameters used. A dedicated button allows, in fact, uploading of these parameters. Otherwise, the STM8 MCU is not updated and default parameters is used for the next switch-on of the thermostat.

The current parameters can also be saved using the GUI. A .tfs file is available for uploading. Please note that in this case, the MCU is not programmed with the current values.

4 Conclusion

This document helps cold appliance designers to use STEVAL-IHT001V2 thermostat kit.

The tool can be used to:

- Check the immunity of this ST solution in standalone mode
- Easily check the appliance efficiency gains by reduction of the hysteresis threshold
- Define better management of the defrost cycles to improve the overall efficiency
- Adapt the software - using the GUI - and the hardware for other dedicated designs (control of different loads (conduction time of the ACS), adapt gate pulse widths and synchronization, implement potentiometer control, implement light dimming, etc.)

Appendix A Thermal sensor linearization

An NTC thermistor is a resistor whose value decreases when its temperature increases. The thermal law is exponential, as shown in [Equation 3](#):

Equation 3

$$R_{NTC}(T) = R_0^{B\left(\frac{1}{T} - \frac{1}{T_0}\right)}$$

To create a simple voltage sensor, it is better to linearize the temperature response using a constant resistor (R49 in schematic, [Appendix B](#)) added in series with the NTC. A voltage divider is then implemented. The voltage across R49 follows the supply voltage (V_{dd}) according to the relationship below:

Equation 4

$$V_S = \frac{R_{NTC}(T)}{R_{NTC}(T) + R_{49}} \cdot V_{dd}$$

To make the relationship of [Equation 4](#) vary linearly, it's sufficient to ensure that the second order derivative is zero. [Equation 5](#) gives the R49 value to ensure this condition.

Equation 5

$$R_{49} = \frac{2 \cdot \left(\frac{d}{dT} R_{NTC}(T) \right)^2}{\frac{d^2}{dT^2} R_{NTC}(T)} - R_{NTC}(T)$$

To linearize the voltage response of the M2020 5 k from EPCOS, between -20 and +5 °C, a 30 kΩ resistor should be chosen for R49.

In this temperature range, V_S varies according to [Equation 6](#), for a 5 V supply:

Equation 6

$$V_I(T) \equiv \frac{T + 51.84}{16.1943}$$

[Figure 10](#) gives the variation of V_S and the linear value given by [Equation 6](#), versus the temperature sensed by the NTC.

Figure 10. Linear voltage in function of the NTC resistor (for a 5 V power supply)

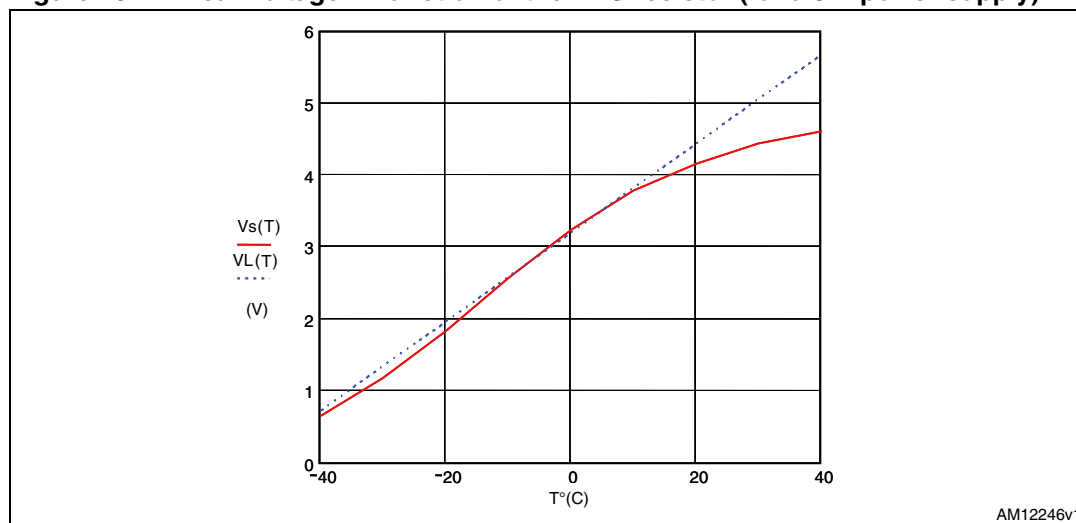
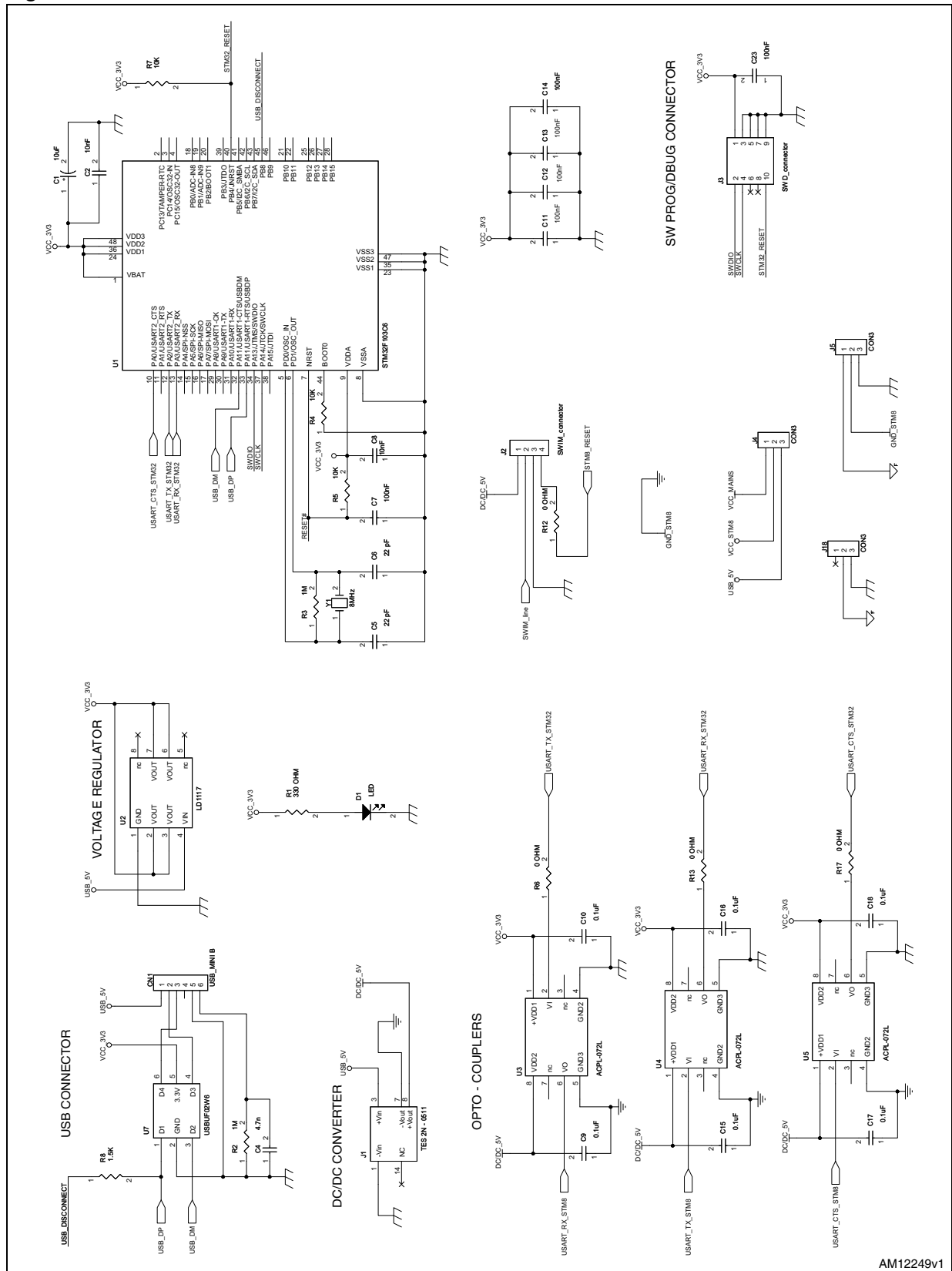
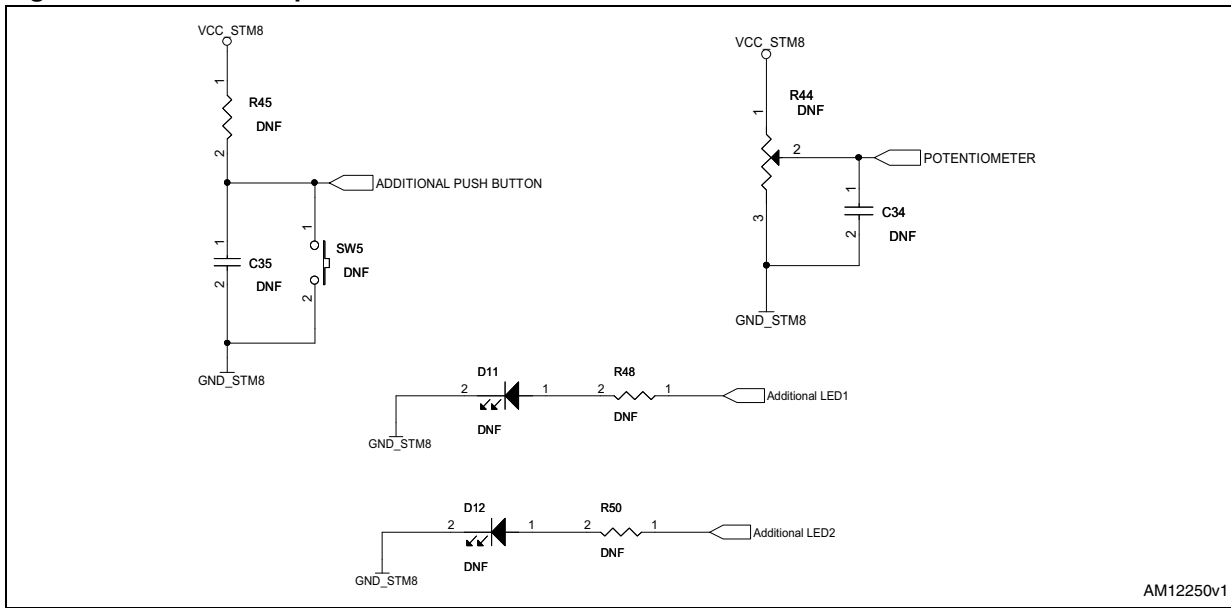

Figure 13. Interface side schematic



AM12249v1

Figure 14. Additional pads schematic



Appendix C Additional pads

Additional pads were added on the board to allow the user to customize his own board, for example to replace the two push buttons for temperature order setting with a potentiometer, add LEDs for further temperature orders, etc. Functionality of additional components is not implemented. These pads are shown in [Figure 14](#) and [15](#) and include:

- One LED replacing the TEMP push button (remove 0 Ω resistor R19, fit LED D11 and resistor R48).
- One LED replacing the buzzer (remove 0 Ω resistor R9 and fit LED D12 and resistor R50)
- One more push button replacing LED2 (remove R33, fit R22, R45, C35 and push button SW5).
- One potentiometer replacing the TEMP+ push button (remove 0 Ω resistor R20, fit R21, C34, and potentiometer R44).

Figure 15. Placement of additional pads

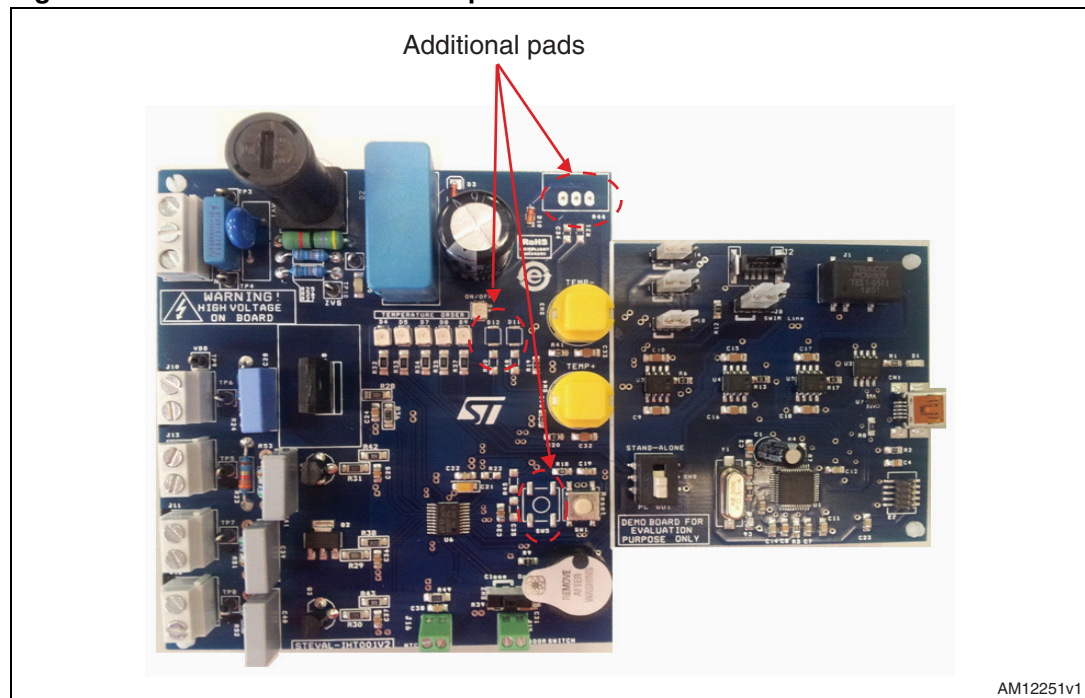

Appendix D Bill of materials

Table 6. BOM

Name	Designation	Comment
CN1	Surface-mount USB_mini-B	
C1	Capacitor 10 μ F 20%	
C2	Capacitor 10 nF 20%	
C4	Capacitor 4.7 nF 20%	
C5	Capacitor 22 pF 20%	
C6	Capacitor 22 pF 20%	
C7	Capacitor 100 nF 20%	
C8	Capacitor 10 nF 20%	
C11	Capacitor 100 nF	
C12	Capacitor 100 nF	
C13	Capacitor 100 nF	
C14	Capacitor 100 nF	
C19	Capacitor 100 nF	
C20	Capacitor 680 nF 20%	
C21	Capacitor 1 μ F 20%	
C22	Capacitor 100 nF	
C23	Capacitor 100 nF 16 V 20%	
C24	1 nF 16 V 20%	
C25	1 nF 16 V 20%	
C26	Capacitor 100 nF X2 400VCC/220VCA	
C27	Capacitor 2200 μ F 16 V 20%	
C28	Capacitor 10 nF 400VCC/220VCA 10%	
C29	Capacitor 1 μ F X2 400VCC/220VCA 10%	
C30	Capacitor 1 nF 50 V	
C31	10 nF 50 V 20%	
C32	10 nF 50 V 20%	
C33	10 nF 50 V 20%	
C34	-	Do not fit
C35	-	Do not fit
C36	1 nF 16 V 20%	
C37	1 nF 16 V 20%	
C38	2.2 nF	

Table 6. BOM (continued)

Name	Designation	Comment
C39	Capacitor 10 nF 400 VCC/220 VCA 10%	
C40	Capacitor 10 nF 400 VCC/220 VCA 10%	
C41	Capacitor 10 nF 400 VCC/220 VCA 10%	
D1	LED	
D2	Zener 5 V 6 0.5 W	
D3	Rectifier 1N4148	
D4	GREEN_LEDs	
D5	GREEN_LEDs	
D6	RED_LED	
D7	GREEN_LEDs	
D8	GREEN_LEDs	
D9	GREEN_LEDs	
D10	Rectifier 1N4148	
D11,D12	Additional LEDs	Do not fit
F1	FUSE	Fuse 8.5 x 8.5 mm 6.3 A 250 V
N/A	FUSEHOLDER	
J1	TES 1-0511	DC-DC converter
J2	SWIM_Connector	4w single row vert male smt connector
J3	SWD Connector	10w dual body, SMT micro terminal strip
J4, J5, J8, J18	CON3	Stripline male 3ways
J14	CON3	Terminal Block, nb contacts 3
J10, J11, J12, J13	Connector CON2	Terminal Block, nb contacts 2
J15 J16	Connector CON2	Terminal Block, nb contacts 2
PZ1	Buzzer	BUZZER 4.0 kHz 1-20 V 80DB
Q1	ACST6	Motor switch
Q2	ACST110	Defrost resistor switch
Q3	ACS102-6TA	Fan / light bulb switch
Q4	ACS102-6TA	Fan / light bulb switch
R1	330 Ω	
R2	1 M Ω	
R3	1 M Ω	
R4	10 k Ω	
R5	10 k Ω	
R6	0	
R7	10 k Ω	

Table 6. BOM (continued)

Name	Designation	Comment
R8	1.5 kΩ	
R12	0	
R13	0	
R17	0	
R18	10 kΩ	
R19	0	
R20	0	
R21	0	Do not fit
R22	0	Do not fit
R23	33 Ω (metallic) 1/2 W 1%	
R24	56 Ω	
R25	47 Ω (metallic) 2 W 1%	
R26	150 kΩ (metallic) 1%	
R27	150 kΩ (metallic) 1%	
R28	100 Ω 5%	
R29	100 Ω 5%	
R30	90 Ω 5%	
R31	90 Ω 5%	
R32	350 Ω 5%	
R33	350 Ω 5%	
R34	350 Ω 5%	
R35	350 Ω 5%	
R36	50 Ω	
R37	350 Ω 5%	
R38	30 Ω	
R39	10 kΩ	
R40	10 kΩ	
R41	10 kΩ	
R42	300 Ω 5%	
R43	300 Ω 5%	
R44	Potentiometer	Do not fit
R45, R48, R50	-	Do not fit
R51, R52, R53	56 Ω	
R49	30 kΩ 5%	
RV1	MOV	

Table 6. BOM (continued)

Name	Designation	Comment
SW1	Push button	Reset
SW2	2 Pos slider	Door Switch
SW3	Push button	T- PUSHBUTTON
SW4	Push button	T+ PUSHBUTTON
SW5	Additional push button	Do not fit
SW8	Slider	PC GUI / standalone selector
TP3, TP4, TP5, TP6, TP7,TP8,TP9, TP10, TP11	Testing points	
U1	STM32F103C6	
U2	LD1117/SO	
U3,U4,U5	ACPL-072L	
U6	STM8S003F3 TSSOP20	
U7	USBUF02W6	
Y1	8 MHz	8 MHz crystal
N/A	Nylon corner spacer: screw	

Appendix E Procedure to apply IEC 61000-4-4 burst test

Fast transient voltage tests have been performed, according to the EN 61000-4-4 standard, on the STEVAL-IHT001V2 board in standalone mode. During the tests, loads were replaced by incandescent lamps in order to visually detect any load spurious turn-on. Arrangements have been taken in order to implement tests in agreement with the EN61000-4-4 standard.

Equipment under test was placed on a ground reference plane, insulated from it by an insulating support 0.1 m ± 0.01 m thick. The NTC (1 m long) (see [Figure 16](#)), and all the cables to the loads were placed on the same insulating support. The power supply to the EUT was placed on an insulation support 0.1 m above the ground reference plane.

Bursts were directly coupled with equipment.

The test generator was placed directly on, and bonded to, the ground reference plane.

The board was not connected to the earthing system.

Figure 16. Test setup

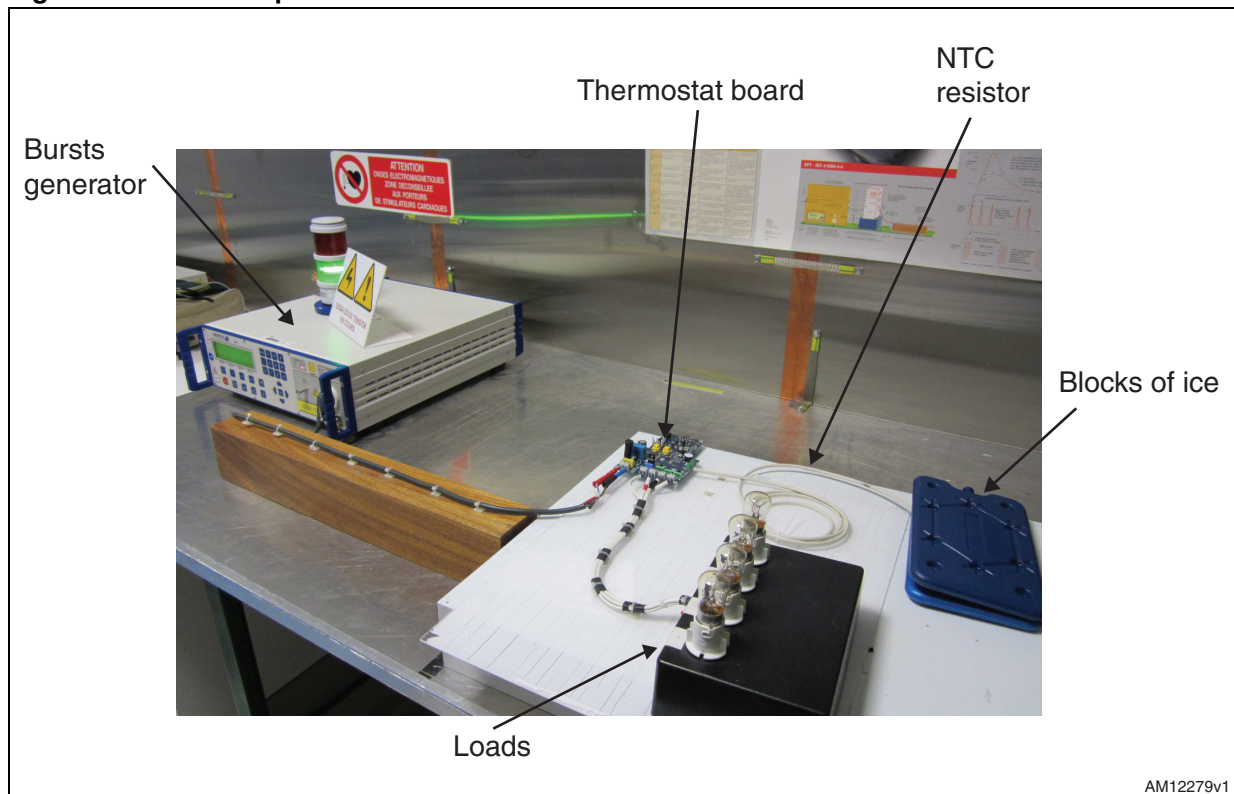

According to the IEC 61000-4-4, the test signals were characterized by:

- Polarity: positive/negative
- Burst duration: 15 ms ± 20% at 5 kHz ([Figure 17](#))
 - 0,75 ms ± 20% at 100 kHz
- Burst period: 300 ms ± 20%
- Duration time: 1 minute
- Applied to: supply voltage line and neutral

The generic graph of a fast transient burst is shown in [Figure 17](#).

Figure 17. General graph of a fast transient/burst

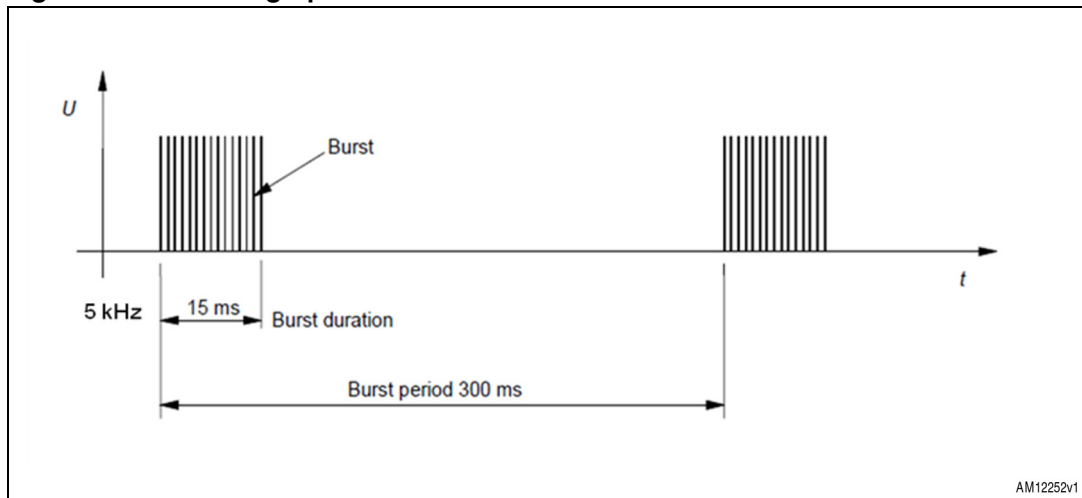

The board withstands up to 4.5 kV and 4.3 kV, positive and negative pulses, respectively at 5 kHz, and up to 3.1 kV, positive and negative pulses, at 100 kHz. At higher voltages, up to 5 kV (at 5 kHz and 100 kHz) temporary disturbance of performance, which ceased after the fast burst voltage ceased, was detected. The equipment under test recovered its normal performance, without operator intervention, after the disturbance ceased.

Note: Because the control firmware loaded in the STEVAL-IHT001V2 board is not optimized for the IEC 61000-4-4 burst test, separate firmware which implements a smart reset procedure (without GUI functions) was used to improve the immunity of the board. This firmware is available on the CD-ROM included with the STEVAL-IHT001V2.

Appendix F STM8 program debugging

A SWIM connector is present on the board to allow programming/debugging operations.

If an expert user wants to reprogram the STM8, they must follow these procedures:

- Programming mode procedure:
 1. Unplug the board from the mains voltage
 2. Ensure that the jumpers and switches are set as indicated in [Table 7](#) - programming mode; in order to provide the MCU with 5 V power supply from USB
 3. Connect the programmer to the SWIM connector (J2 in [Figure 5](#))
 4. Plug in the mini-USB
 5. Continue with usual programming procedures.

Only if an insulated AC source is used to supply the mains voltage, can the board be used in debug mode, i.e. both the communication side and the control side are supplied by the USB, but the ACS are supplied by the mains voltage and the board is fully working.

- Debugging mode procedure:
 1. Plug an insulated AC source to supply STEVAL-IHT001V2 board (J14 header)
 2. Connect the loads on the thermostat board (see [Figure 2](#))
 3. Ensure that the jumpers and switches are set as indicated in [Table 7](#) - debugging mode; in order to provide the MCU with 5 V power supply from USB
 4. Plug in the mini-USB
 5. Power on the insulated AC source
 6. Continue with usual debugging procedures.

This operating mode is allowed only for expert users.

Warning: Please take careful note of the jumper configuration given in [Table 7](#) before powering up the board, whatever the mode of operation. Incorrect jumper configuration with a non-insulated power source may result in damage to the PC.

Table 7. Jumper configuration in programming and debugging modes







Jumper	Programming mode	Debugging mode ⁽¹⁾	Description
J4			
J5			

Table 7. Jumper configuration in programming and debugging modes

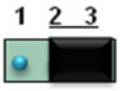
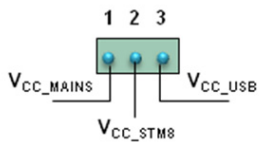
Jumper	Programming mode	Debugging mode ⁽¹⁾	Description
J8			 <p>PD1/SWIM pin</p> <p>LED₃ 2 SWIMline</p>
J18		 ⁽²⁾	 <p>1 2 3</p> <p>GND_MAINS GND_USB</p>

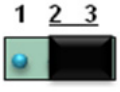
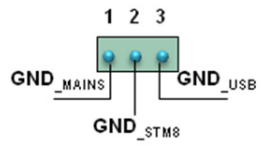
1. This debugging mode refers to the possibility to potentially debug a new different firmware uploaded in the STM8 microcontroller. Do not mistake with “Debug mode” described in [Section 3.6.3](#), since it means an operating mode offered by the PC-GUI software, nothing to do with the debugging of firmware.
2. Only if an insulated power source is used.

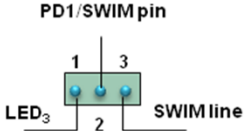
Appendix G PC interface parameters description

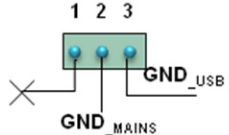
Output in the table below is defined as the information sent by the STM8S MCU to the STM32, and input is the contrary.

Table 8. PC interface parameters

Parameter	Software type	Unit	Factory setting	Allowable range	Setting step
Temperature hysteresis	Input/output	°C	4	0.5 to 20	0.1
Evaporator temperature	Output	°C	N/A	-40 to +40	
Evaporator temperature order 1	Input/output	°C	-5	-40 to 10	0.5
Evaporator temperature order 2	Input/output	°C	-12	-40 to 10	0.5
Evaporator temperature order 3	Input/output	°C	-20	-40 to 10	0.5
Evaporator temperature order 4	Input/output	°C	-28	-40 to 10	0.5
Evaporator temperature order 5	Input/output	°C	-36	-40 to 10	0.5
Compressor phase shift	Input/output	ms	0.5	0.1 to 5	0.1
Gate current pulse width for compressor control	Input/output	ms	3	0.1 to 4	0.1
Gate current pulse width for bulb control	Input/output	ms	5	0.1 to 5	0.1
Gate current pulse width for defrost resistor control	Input/output	ms	1	0.1 to 3	0.1
Gate current pulse width for fan	Input/output	ms	2	0.1 to 3	0.1
Fan phase shift	Input/output	ms	0.5	0.1 to 5	0.1
Defrost activation delay	Input/output	Hours and minutes	8	1 to 99	10'
Defrost duration	Input/output	Minutes and seconds	20	1 to 60	10'
ZVS delay	Input/output	µs	50	5 to 255	5
Line frequency	Output	Hz	N/A	50 / 60	

Appendix H Capacitor value according to country

[Table 9](#) indicates the capacitor value for a 30 mA average current for typical application case (nominal capacitor value, nominal RMS line voltage) versus different AC mains and frequency values used in different countries.

Moreover, the typical and minimal (nominal capacitor value -10%, minimum RMS line voltage) output DC current capabilities are included for information.

Table 9. C29 capacitor value according to the country

Country	Typical RMS voltage	Minimum RMS voltage	Frequency	C29 capacitor	Output DC current for typical application conditions	Min. output DC current capabilities for worst application case
Japan	100 V	90 V	50/60 Hz	2.2 μ F	31.1 mA	25.2 mA
USA	120 V	100	60 Hz	1.5 μ F	30.5 mA	22.9 mA
Brazil, Mexico	120 V to 240 V	102 V to 204 V	50/60 Hz	2.2 μ F	37.3 mA	28.5 mA
Europe, China, Korea, Australia	220 V to 240 V	187 V to 204 V	50/60 Hz	1 μ F	31.1 mA	23.8 mA

Revision history

Table 10. Document revision history

Date	Revision	Changes
10-Sep-2012	1	Initial release.

Please Read Carefully:

Information in this document is provided solely in connection with ST products. STMicroelectronics NV and its subsidiaries ("ST") reserve the right to make changes, corrections, modifications or improvements, to this document, and the products and services described herein at any time, without notice.

All ST products are sold pursuant to ST's terms and conditions of sale.

Purchasers are solely responsible for the choice, selection and use of the ST products and services described herein, and ST assumes no liability whatsoever relating to the choice, selection or use of the ST products and services described herein.

No license, express or implied, by estoppel or otherwise, to any intellectual property rights is granted under this document. If any part of this document refers to any third party products or services it shall not be deemed a license grant by ST for the use of such third party products or services, or any intellectual property contained therein or considered as a warranty covering the use in any manner whatsoever of such third party products or services or any intellectual property contained therein.

UNLESS OTHERWISE SET FORTH IN ST'S TERMS AND CONDITIONS OF SALE ST DISCLAIMS ANY EXPRESS OR IMPLIED WARRANTY WITH RESPECT TO THE USE AND/OR SALE OF ST PRODUCTS INCLUDING WITHOUT LIMITATION IMPLIED WARRANTIES OF MERCHANTABILITY, FITNESS FOR A PARTICULAR PURPOSE (AND THEIR EQUIVALENTS UNDER THE LAWS OF ANY JURISDICTION), OR INFRINGEMENT OF ANY PATENT, COPYRIGHT OR OTHER INTELLECTUAL PROPERTY RIGHT.

UNLESS EXPRESSLY APPROVED IN WRITING BY TWO AUTHORIZED ST REPRESENTATIVES, ST PRODUCTS ARE NOT RECOMMENDED, AUTHORIZED OR WARRANTED FOR USE IN MILITARY, AIR CRAFT, SPACE, LIFE SAVING, OR LIFE SUSTAINING APPLICATIONS, NOR IN PRODUCTS OR SYSTEMS WHERE FAILURE OR MALFUNCTION MAY RESULT IN PERSONAL INJURY, DEATH, OR SEVERE PROPERTY OR ENVIRONMENTAL DAMAGE. ST PRODUCTS WHICH ARE NOT SPECIFIED AS "AUTOMOTIVE GRADE" MAY ONLY BE USED IN AUTOMOTIVE APPLICATIONS AT USER'S OWN RISK.

Resale of ST products with provisions different from the statements and/or technical features set forth in this document shall immediately void any warranty granted by ST for the ST product or service described herein and shall not create or extend in any manner whatsoever, any liability of ST.

ST and the ST logo are trademarks or registered trademarks of ST in various countries.

Information in this document supersedes and replaces all information previously supplied.

The ST logo is a registered trademark of STMicroelectronics. All other names are the property of their respective owners.

© 2012 STMicroelectronics - All rights reserved

STMicroelectronics group of companies

Australia - Belgium - Brazil - Canada - China - Czech Republic - Finland - France - Germany - Hong Kong - India - Israel - Italy - Japan - Malaysia - Malta - Morocco - Philippines - Singapore - Spain - Sweden - Switzerland - United Kingdom - United States of America

www.st.com

